



*Burlington*<sup>®</sup>

Burlington enables homeowners to create bathrooms with the authentic forms and finishes from pivotal periods of design but made to modern quality and performance standards.

Burlington brings the finest quality complete traditional bathroom ranges with genuine and inspired designs from the late 19th Century through to the 1930s. In an age of minimalism and stark, functional spaces, Burlington offers a sanctuary for those who seek the comfort, familiarity and reassurance of more traditional styling. Burlington's collections include everything you need; brassware, ceramics, furniture, baths, shower enclosures, towel radiators and accessories.



Edwardian 1200mm double basin with washstand | Claremont three tap hole deck mounted mixer | Towel ring | All fittings, brassware and accessories are in Gold

# INSPIRATION

02 FREESTANDING CLASSICS

10 ELEGANT EDWARDIAN

22 OPULENT VICTORIAN

30 A MODERN TWIST

40 CHALFONT CHIC

48 ICONIC RIVIERA

56 CLOAKROOMS

# TECHNICAL DIRECTORY

66 WCs

82 BASINS

98 FURNITURE

112 BATHS

122 BRASSWARE

132 SHOWERING

154 ACCESSORIES



1300mm freestanding vanity unit with doors, White with Minerva Carrara marble worktop | Chelsea straight basin mixers with pop up waste

# FREESTANDING CLASSICS

**Functional. Time-honoured. Traditional.**

Captivating and timeless designs are captured by our Freestanding furniture units, combining classic styling with the practicality of ample storage. Perfect for incorporating in modern or traditional bathroom designs a-like, to maximise storage with a timeless look. Sophisticated storage with modern-day performance, from smaller basin units to impressive vanity units, square edges or softer curves, in a selection of tasteful hues our Freestanding furniture will enhance your bathroom design.



Regal high level WC with flush pipe, dual flush ceramic cistern and cover caps | Soft close seat, Green | WC roll holder | Towel ring | Regent 3 tap hole mixer with Claremont handles | 750mm freestanding vanity unit with doors, Green with Minerva White worktop | Rectangular swivel mirror with curved corners | Walk in, corner with T brace | Avon thermostatic shower with wall bracket, handset and 9" head | Bloomsbury radiator | All fittings and accessories are in Brushed Nickel





Regal high level WC with flush pipe, dual flush ceramic cistern and cover caps | Soft close seat, Grey | WC roll holder | Towel ring | Soap dish | Regent three tap hole mixer with Claremont handles | 1340mm freestanding curved vanity unit with drawers, Grey with Minerva Carrara worktop | Framed mirror with LED illumination, Grey | Walk In, corner with hinged deflector | Trent thermostatic shower with wall bracket, handset and 9" head | All fittings and accessories are in Gold







Standard low level WC with flush pipe, lever and cover caps | Soft close seat, Blue | WC roll holder | Towel ring | Regent three tap hole with Claremont handles | Curved 1340mm freestanding vanity unit with doors, Blue with Minerva Carrara marble worktop | Framed 1200mm mirror with LED illuminations, Blue / Admiral 1650mm bath | Deck mounted bath shower mixer with Claremont handles | Stand pipes | All fittings and accessories are in Gold





Edwardian 1200mm double basin with washstand | Three tap hole mixers with Claremont handles | Towel rings | All fittings and accessories are in Gold

# ELEGANT EDWARDIAN

**Classic. Soothing. Refreshing.**

Famed for their restorative properties, Edwardian design took inspiration from the styles of the previous centuries whilst focusing on making comfort a high priority. Warming neutrals lay the perfect foundation with their soft, balanced hues helping to create a lighter cosy homeliness. A perfect pairing with expressive coloured tiles or patterned wallpaper, Edwardian style provides complete contentment without having to compromise on a look that dates.



Right: Edwardian 560mm basin with full pedestal | 5" pillar tap with Claremont handles | Standard close coupled WC with lever | Soft close seat, White  
Above: London round bath | Deck mounted bath shower mixer with White Kensington handles | Stand pipes | Brass extendible bath rack |  
All fittings, brassware and accessories are in Chrome





Hampton 1500mm bath with traditional feet | Single bathscreen | Tay exposed shower with 9" shower head | Edwardian 560mm basin with full pedestal | Three tap hole mixer with Kensington handles | Towel ring | WC roll holder | WC brush holder | Rectangular mirror | Round lights with vase glass shades | Regal close coupled WC with lever | Soft close seat, Oak | Bloomsbury radiator | All fittings, brassware and accessories are in Chrome







THE  
Burlington  
Patent Cistern



Edwardian 1200mm basin with washstand | Three tap hole mixer with Claremont handles | Standard 440 medium level WC with Chrome cistern with flush pipe and lever | Soft close seat, White | Seat handles | All fittings, brassware and accessories are in Chrome





Left: Three tap hole mixer with Birkenhead handles / Soap dish / Standard 520 low level WC with flush pipe and lever | Soft close seat, White | WC roll holder  
Above: Edwardian 800mm basin with washstand | All fittings, brassware and accessories are in Chrome





Above Clockwise: Edwardian 515mm cloakroom basin | Towel rail | 3" pillar taps with Claremont handles / Claremont Bath Shower Mixer Deck Mounted / Standard 520 medium level WC with flush pipe and lever | Soft close seat, Oak / Glass shelf with railing / All fittings, brassware and accessories are in Chrome  
 Left: Edwardian 560mm round basin with washstand | 3" pillar taps with White Kensington handles | Tumbler holder and spare WC roll holder | Back to wall WC with concealed cistern and lever | Soft close seat, White | All fittings, brassware and accessories are in Chrome



Victorian 610mm basin with full pedestal | 5" pillar taps with Claremont handles | Rectangular mirror with rounded corners | Soap dispenser | Glas shelf | Toilet brush | Toilet roll holder | Standard 520 close coupled WC with lever and cover caps | Soft close seat, Green | All fittings, brassware and accessories are in Gold



# OPULENT VICTORIAN

**Decorative. Characterful. Ornate.**

Discover the delightful details of Victorian design, whether you are looking to restore your home to full Victorian splendor or you want to add some character to your modern home. The Victorian era was all about mixing and matching styles to create an impactful interior, be inspired by the distinct style of this era and make your own modern day statement. Our Victorian products are the perfect partner for patterned wallpapers with rich colours or light and airy interiors alike.





Victorian 610mm basin with full pedestal | 5" pillar taps with Claremont handles | Rectangular mirror with rounded corners | Soap dispenser | Glass shelf | Toilet brush | Toilet roll holder | Arundel Double Ended 1700x700 with side panels, Green | Bath shower mixer wall mounted with Claremont handles | All fittings, brassware and accessories are in Gold



Victorian 560mm basin with regal stand and towel rack | 3" pillar taps with Claremont handles | Tumbler | Towel ring | WC roll holder | Standard 520 low level WC with flush pipe, lever and cover caps | Soft close seat, White | Arundel 1700mm x 700mm bath with panels, White | Deck mounted bath shower mixer | All fittings, brassware and accessories are in Gold





Victorian 610mm basin with full pedestal | 5" pillar taps with Claremont handles | Standard 520 close coupled WC with lever | Soft close seat, White | Avon exposed shower with 9" shower head | Sliding door enclosure and tray | Trafalgar radiator | All fittings, brassware and accessories are in Chrome





Contemporary Upstand 560mm basin with stand and towel rack | Mono basin mixer with Claremont handles | Soap dish | Towel ring | Rectangular mirror with curved corners | All fittings, brassware and accessories are in Brushed Nickel



# A MODERN TWIST

**Contemporary. Time-honoured. Everlasting.**

Known as the principles of art; balance, harmony and proportion are often cited within classic bathrooms inspired by eminent eras such as Victorian, Edwardian and Art Deco. Defined by symmetry, soft corners and structure, classic bathrooms maximise comfort by combining traditional design with modern-day elements. Whether you love the look of traditional or prefer the modern feel, our contemporary collections unite form and function for elegantly refined designs.





Contemporary Upstand 560mm basin with stand and towel rack | Mono basin mixer with Claremont handles | Soap dish | Towel ring | Standard 520 close coupled WC with lever and cover caps | Soft close seat, White | Walk in, recess with hinged deflector | Avon thermostatic shower with wall bracket, handset and 9" head | Trafalgar radiator | All fittings, brassware and accessories are in Brushed Nickel



Classic 650mm rectangular basin with invisible overflow with pedestal | 5" pillar taps with Claremont handles | Tumbler holder | Towel ring | All fittings, brassware and accessories are in Chrome





Contemporary 580mm basin with semi pedestal | Mono basin mixer with Claremont handles | WC roll holder | Soap dispenser | Triple robe hook | WC brush holder | Ornate lights with tube frosted glass | Wall hung WC with concealed cistern and lever | Soft close seat, White | All fittings, brassware and accessories are in Chrome



Top: Classic 510mm square basin with washstand | 3" pillar taps with Claremont handles | Soap dish / Bottom: Admiral 1650mm bath | Deck mounted bath shower mixer with Kensington handles | Stand pipes | All fittings, brassware and accessories are in Chrome



Balthazar bath with stainless steel outer | Deck mounted bath shower mixer with Kensington handles | Stand pipes | All fittings, brassware and accessories are in Chrome







Chalfont 750mm vanity unit Black with large roll top basin, Gold legs and handle | Mono basin mixer with Claremont handles | Towel ring | All fittings, brassware and accessories are in Gold

# CHALFONT CHIC

**Original. Timeless. Iconic.**

A seamless blend of classic and contemporary, modern traditional bathrooms unites extraordinary eras of design to instil newfound comfort. Revolving around an assortment of textures, colours and styles, modern traditional bathrooms can be as classic or contemporary as desired to match individual preference. Beautifully paired with Chrome, Gold or Brushed Nickel, modern traditional bathrooms create design freedom with a look that lasts.





Chalfont 750mm vanity unit Black with large roll top basin, Gold legs and handle | Mono basin mixer with Claremont handles | Towel ring | Rectangular mirror with curved corners | Standard 520 low level WC with flush pipe, lever and cover caps | Soft close seat, White | Avon exposed shower with 9" shower head | Burlington walk in shower enclosure | 45mm Shower tray with Gold waste cover | Trafalgar radiator | All fittings, brassware and accessories are in Gold



Chalfont 650mm vanity unit in Blue with medium roll top basin, Blue legs and Brushed Nickel handle | Arcade three tap hole mixer with crosshead lever | Tumbler holder | Towel ring | WC roll holder | Rectangular swivel mirror | Oval lights with White fine pleated shade | Standard high level dual flush WC with flush pipe | Soft close seat, Blue | Bateau bath | All fittings, brassware and accessories are in Brushed Nickel









Chalfont 550mm vanity unit Blue with small roll top basin with Gold legs and handle | Mirrored cabinet, Blue | Soap dish | Towel ring | Standard high level dual flush WC with flush pipe and cover caps | Soft close seat, Blue | All fittings and accessories are in Gold



Riviera close coupled open-backed WC | Riviera soft close seat | Riviera 580mm vanity unit Pink with handles and Riviera square basin | Riviera three tap hole mixer | Single soap dispenser | All fittings, brassware and accessories are in Gold

# ICONIC RIVIERA

**Lavish. Luxurious. Exclusive.**

Created in collaboration with Christian Booth Design, the Riviera Collection reignites the spirit of the 1920s with a curated selection of ceramics, vanity units and brassware. Drawing on the extravagance of the Mediterranean coasts, Riviera balances clean lines, geometric shapes and decorative embellishments to bring Art Deco designs into homes of today. Faithful to the original and entirely transitional, the Riviera Collection seeks to unite glamour, style and luxury in one comprehensive collection to inspire an Art Deco bathroom unlike any other.



Riviera 650mm vanity unit White with handles and Riviera square basin | Riviera three tap hole mixer | Riviera wall hung WC with concealed cistern | Crosswater glass flush plate | Riviera soft close seat | Riviera four hole bath mixer including handset and pull out hose | Clearwater Patinato Petite Bath | All fittings, brassware and accessories are in Chrome





Riviera dual valve, slide rail, handset and hose, and 9" shower head | Riviera 580mm D shaped basin with semi pedestal | Towel ring | Shower basket | WC roll holder | Arched mirror | Round lights with tube frosted glass shades | Riviera wall hung WC with concealed cistern and lever | Riviera soft close seat | All fittings, brassware and accessories are in Chrome









Riviera back to wall WC | Riviera soft close seat | Riviera cistern flush lever | Riviera 650mm vanity unit in Blue with handles and Riviera square basin | Riviera wall mounted basin mixer | Soap dish | All fittings, brassware and accessories are in Chrome



Freestanding 50cm basin unit with Door in Matt White with 50cm Classic basin | Chelsea straight basin mixer without waste | All fittings and brassware are in Chrome

# CLOAKROOMS

**Compact. Sophisticated. Endearing.**

Just as exciting as renovating the bathroom, the process of bringing an impressive design statement to a compact cloakroom space can feel particularly rewarding. The task of transforming a cloakroom is not only an exciting one, but an effortless one with an extensive selection of products specially designed to enhance these smaller areas. Whether you're looking for Victorian, Edwardian, Art Deco or freestanding designs, with Burlington you can find the perfect solution for your cloakroom.



Riviera 450mm cloakroom basin | Riviera pillar taps | Soap dish | Towel ring | WC roll holder | Riviera back to wall WC with concealed cistern and lever | Riviera soft close seat | All fittings, brassware and accessories are in Gold







Edwardian 515mm cloakroom basin with washstand | 3" pillar taps with Claremont handles | Towel ring | WC roll holder | Wall hung WC with concealed cistern and lever | Soft close seat, White | All fittings, brassware and accessories are in Gold



Edwardian 515mm cloakroom basin | 3" pillar taps with Claremont handles | Soap dish | Towel ring | WC roll holder | WC brush holder | Rectangular mirror | Edwardian single round LED light | Back to wall WC with concealed cistern and lever | Soft close seat, White | All fittings, brassware and accessories are in Chrome





# TECHNICAL DIRECTORY

You have now been introduced to the wide scope of the Burlington collections, all designed and engineered to provide solutions for your bathroom. The following Technical Directory provides a full listing of the Burlington products including product codes and dimensions. Whatever you choose, we are sure you will be delighted with your traditional bathroom by Burlington.  
Visit our website [burlingtonbathrooms.com](http://burlingtonbathrooms.com) if you need further details.



Regent three tap hole mixer with Claremont handles | Towel ring | 750mm freestanding vanity unit with doors, Green with Minerva White worktop | Rectangular swivel mirror with curved corners | All fittings and accessories are in Brushed Nickel

# TECHNICAL DIRECTORY

66

WCs

82

BASINS

98

FURNITURE

112

BATHS

122

BRASSWARE

132

SHOWERING

154

ACCESSORIES

# WCs

The widest range of traditional WC options to suit your installation and match the exact look you want. Available in White with finish options of Chrome, Gold and Brushed Nickel flush pipes.

---

## PAN OPTIONS

Choose between Standard or Regal WCs with an option of Rimless pans available across a number of our products.



### Regal

At Burlington we've created a range that's taller than average sanitaryware. Regal WC pans are 60mm higher than the standard option.



### Standard

Our standard WC offers a pan that is 420mm with a box rim. A popular choice for creating a traditional look in your bathroom.



### Rimless

The rimless WC is exceptionally easy to keep clean. Its powerful flush covers the entire bowl, making it the most hygienic option.

---

## STYLE OPTIONS

Burlington has a wide range of WCs options. Select your style below.



Wall-hung



Back-to-wall



Close-coupled



Low level



Medium level



High level

# WCs

68

CLOSE COUPLED

70

LOW LEVEL

72

MEDIUM LEVEL

74

HIGH LEVEL

76

OTHERS

77

ARCADE

78

SEATS & ACCESSORIES

80

RIVIERA

## QUALITY

For peace of mind our WCs have the following benefits.



All Burlington close-coupled WCs are supplied with dual flush WRAS fittings.



All WCs have a unique stay-clean NANO Glaze coating, creating an ultra-smooth surface, six times smoother than standard ceramic.

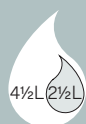

All Burlington WC fittings are factory set at 3L and 6L flush. They can be adjusted on site to flush at 2½L and 4½L.

## GUARANTEES

\*The lifetime guarantee is subject to online registration and represents the perceived lifetime of the product which is 25 years. For full details on guarantees please visit [burlingtonbathrooms.com/guarantee](http://burlingtonbathrooms.com/guarantee).

WCs

LIFETIME

Guarantee\*

# CLOSE COUPLED

---

## Standard Close Coupled WC



### 520 Cistern with Lever

W: 520 D: 730 H: 780

Codes: P5 + C1

### 440 Cistern with Lever

W: 440 D: 730 H: 780

Codes: P5 + C3

### 520 Cistern with Button

W: 520 D: 730 H: 780

Codes: P5 + C2

### 440 Cistern with Button

W: 440 D: 730 H: 780

Codes: P5 + C4

---

## Regal Close Coupled WC



### 520 Cistern with Lever

W: 520 D: 730 H: 845

Codes: P12 + C1

### 440 Cistern with Lever

W: 440 D: 730 H: 845

Codes: P12 + C3

### 520 Cistern with Button

W: 520 D: 730 H: 845

Codes: P12 + C2

### 440 Cistern with Button

W: 440 D: 730 H: 845

Codes: P12 + C4

---

## Rimless Close Coupled WC



### 520 Cistern with Lever

W: 520 D: 730 H: 780

Codes: P20 + C1

### 440 Cistern with Lever

W: 440 D: 730 H: 780

Codes: P20 + C3

### 520 Cistern with Button

W: 520 D: 730 H: 780

Codes: P20 + C2

### 440 Cistern with Button

W: 440 D: 730 H: 780

Codes: P20 + C4

Please note: Seats sold separately

For alternative Lever finishes,  
See page 79.

S Trap Close Coupled WC



**520 Cistern with Lever**

**W: 520 D: 710 H: 780**

**Codes: P18 + C1**

**440 Cistern with Lever**

**W: 440 D: 710 H: 780**

**Codes: P18 + C3**

**520 Cistern with Button**

**W: 520 D: 710 H: 780**

**Codes: P18 + C2**

**440 Cistern with Button**

**W: 440 D: 710 H: 780**

**Codes: P18 + C4**

Back entry cistern option available, see page 79



Available with  
Gold Levers.  
See page 79

For full details on our WC ranges go to [burlingtonbathrooms.com/guides/toilets](http://burlingtonbathrooms.com/guides/toilets)

# LOW LEVEL



---

## Standard Low Level WC

### 520 Cistern with Lever

W: 520 D: 740 H: 1075

Codes: P2 + C1 + T31 CHR

### 440 Cistern with Lever

W: 440 D: 740 H: 1075

Codes: P2 + C3 + T31 CHR

### 520 Cistern with Button

W: 520 D: 740 H: 1075

Codes: P2 + C2 + T31 CHR

### 440 Cistern with Button

W: 440 D: 740 H: 1075

Codes: P2 + C4 + T31 CHR



---

## Regal Low Level WC

### 520 Cistern with Lever

W: 520 D: 740 H: 1075

Codes: P16 + C1 + T31 CHR

### 440 Cistern with Lever

W: 440 D: 740 H: 1075

Codes: P16 + C3 + T31 CHR

### 520 Cistern with Button

W: 520 D: 740 H: 1075

Codes: P16 + C2 + T31 CHR

### 440 Cistern with Button

W: 440 D: 740 H: 1075

Codes: P16 + C4 + T31 CHR



---

## S Trap Low Level WC

### 520 Cistern with Lever

W: 520 D: 740 H: 1075

Codes: P19 + C1 + T31 CHR

### 440 Cistern with Lever

W: 440 D: 740 H: 1075

Codes: P19 + C3 + T31 CHR

### 520 Cistern with Button

W: 520 D: 740 H: 1075

Codes: P19 + C2 + T31 CHR

### 440 Cistern with Button

W: 440 D: 740 H: 1075

Codes: P19 + C4 + T31 CHR

Back entry cistern option available, see page 79

Please note: Seats sold separately



For alternative Lever and Flush Pipe finishes,  
See page 79.



Standard Chrome Cistern Low Level WC

**440 Cistern with Lever**

**W: 440 D: 740 H: 1130**

**Codes: P2 + T71 CHR + T31 CHR**



For full details on our WC ranges go to [burlingtonbathrooms.com/guides/toilets](https://burlingtonbathrooms.com/guides/toilets)

# MEDIUM LEVEL

---

## Standard Medium Level WC



### 520 Cistern with Lever

W: 520 D: 720 H: 1425

Codes: P5 + C1 + T33 CHR

### 440 Cistern with Lever

W: 440 D: 720 H: 1425

Codes: P5 + C3 + T33 CHR

### 520 Cistern with Button

W: 520 D: 720 H: 1425

Codes: P5 + C2 + T33 CHR

### 440 Cistern with Button

W: 440 D: 720 H: 1425

Codes: P5 + C4 + T33 CHR

---

## Regal Medium Level WC



### 520 Cistern with Lever

W: 520 D: 720 H: 1425

Codes: P12 + C1 + T33 CHR

### 440 Cistern with Lever

W: 440 D: 720 H: 1425

Codes: P12 + C3 + T33 CHR

### 520 Cistern with Button

W: 520 D: 720 H: 1425

Codes: P12 + C2 + T33 CHR

### 440 Cistern with Button

W: 440 D: 720 H: 1425

Codes: P12 + C4 + T33 CHR

---

## Rimless Medium Level WC



### 520 Cistern with Lever

W: 520 D: 720 H: 1425

Codes: P20 + C1 + T33 CHR

### 440 Cistern with Lever

W: 440 D: 720 H: 1425

Codes: P20 + C3 + T33 CHR

### 520 Cistern with Button

W: 520 D: 720 H: 1425

Codes: P20 + C2 + T33 CHR

### 440 Cistern with Button

W: 440 D: 720 H: 1425

Codes: P20 + C4 + T33 CHR

Please note: Seats sold separately



---

### S Trap Medium Level WC

#### 520 Cistern with Lever

**W:** 520 **D:** 710 **H:** 1425

**Codes:** P18 + C1 + T33 CHR

#### 440 Cistern with Lever

**W:** 440 **D:** 710 **H:** 1425

**Codes:** P18 + C3 + T33 CHR

#### 520 Cistern with Button

**W:** 520 **D:** 710 **H:** 1425

**Codes:** P18 + C2 + T33 CHR

#### 440 Cistern with Button

**W:** 440 **D:** 710 **H:** 1425

**Codes:** P18 + C4 + T33 CHR

Back entry cistern option available, see page 79



---

### Standard Chrome Level Medium Level WC

#### 440 Cistern with Lever

**W:** 440 **D:** 730 **H:** 1425

**Codes:** P5 + T71 CHR + T33 CHR

---

## CHOOSE YOUR PAN

Choose between Standard or Regal WCs with an option of Rimless pans available across a number of our products.

#### Standard

Our standard WC offers a pan that is 420mm with a box rim. A popular choice for creating a traditional look in your bathroom.

#### Regal

At Burlington we've created a range that's taller than average sanitaryware. Regal WC pans are 60mm higher than the standard option.

#### Rimless

The rimless WC is exceptionally easy to keep clean. Its powerful flush covers the entire bowl, making it the most hygienic option.

For full details on our WC ranges go to [burlingtonbathrooms.com/guides/toilets](http://burlingtonbathrooms.com/guides/toilets)

# HIGH LEVEL



## Standard High Level WC

**520 Cistern with Dual Flush**

**W:** 520 **D:** 670 **H:** 2380

**Codes:** P2 + C5 + T30 CHR

**520 Cistern with Single Flush**

**W:** 520 **D:** 670 **H:** 2380

**Codes:** P2 + C28S + T30 CHR

**430 Aluminium Cistern with Dual Flush**

**W:** 430 **D:** 670 **H:** 2380

**Brushed:** P2 + T58 ALU + T30 CHR

**Black:** P2 + T60 BLA + T30 CHR

**White:** P2 + T59 WHI + T30 CHR



## Regal High Level WC

**520 Cistern with Dual Flush**

**W:** 520 **D:** 670 **H:** 2380

**Codes:** P16 + C5 + T30 CHR

**520 Cistern with Single Flush**

**W:** 520 **D:** 670 **H:** 2380

**Codes:** P16 + C28S + T30 CHR

**430 Aluminium Cistern with Dual Flush**

**W:** 430 **D:** 670 **H:** 2380

**Brushed:** P16 + T58 ALU + T30 CHR

**Black:** P16 + T60 BLA + T30 CHR

**White:** P16 + T59 WHI + T30 CHR



## S Trap High Level WC

**520 Cistern with Dual Flush**

**W:** 520 **D:** 670 **H:** 2380

**Codes:** P19 + C5 + T30 CHR

**520 Cistern with Single Flush**

**W:** 520 **D:** 670 **H:** 2380

**Codes:** P19 + C28S + T30 CHR

**430 Aluminium Cistern with Dual Flush**

**W:** 440 **D:** 670 **H:** 2380

**Brushed:** P19 + T58 ALU + T30 CHR

**Black:** P19 + T60 BLA + T30 CHR

**White:** P19 + T59 WHI + T30 CHR

Back entry cistern option available, see page 79

Please note: Seats sold separately

For alternative Lever and Flush Pipe finishes,  
See page 79.

---

### High Level WC with Angled Flush Pipe

#### 520 Cistern with Dual Flush

W: 905 D: 700 H: 2725

Codes: P2 + C5 + T34 CHR

Angled flush pipes can be ordered as an extra on all high level WCs

---

### High Level Chrome WC

#### 440 Cistern with Dual Flush

W: 440 D: 670 H: 2400

Codes: P2 + T70 CHR + T30 CHR



---

## REGAL WCs

At Burlington we've created a range that's taller than average sanitaryware. Regal WC pans are 60mm higher than the standard option.

At 480mm high the taller WC pan ensures the knee angle remains at approximately 90 degrees whilst in use, which is the correct seating position. The taller WC provides a more comfortable use for taller people and the elderly whilst ensuring your WC is functional as well as beautiful too.



For full details on our WC ranges go to [burlingtonbathrooms.com/guides/toilets](http://burlingtonbathrooms.com/guides/toilets)

# OTHERS



---

## Back to Wall

### Standard

**W:** 360 **D:** 475 **H:** 425

**Code:** P14

### Regal

**W:** 370 **D:** 480 **H:** 480

**Code:** P15

### Standard Rimless

**W:** 360 **D:** 480 **H:** 420

**Code:** P21



---

## Wall Hung

**W:** 335 **D:** 500

**Code:** P10



---

## Bidets

### Floorstanding

**W:** 400 **D:** 570 **H:** 400

**Code:** P4

Please note: Seats sold separately

# ARCADE



Arcade

**Close Coupled**

**W: 500 D: 670 H: 885**

**Codes: ARC4 + ARC5**

**Back to Wall**

**W: 365 D: 520 H: 460**

**Code: ARC6**



For full details on our WC ranges go to [burlingtonbathrooms.com/guides/toilets](http://burlingtonbathrooms.com/guides/toilets)

# SEATS & ACCESSORIES



Matt White soft-close seat  
(excluding handles)

**Code:** S45

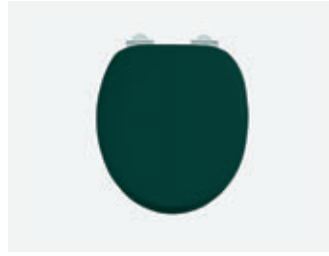

Green soft-close seat  
(excluding handles)

**Code:** S102



Classic Grey soft-close seat  
(excluding handles)

**Code:** S46



Blue soft-close seat  
(excluding handles)

**Code:** S99



Black soft-close seat  
(excluding handles)

**Matt:** S48  
**Gloss:** S40



Medici soft-close seat  
(excluding handles)

**Code:** S50



Oak seat  
(excluding handles)

**Standard:** S11  
**Soft-close:** S16



Gloss Mahogany seat  
(excluding handles)

**Standard:** S12  
**Soft-close:** S17



White carbamide seat  
(not suitable for handles)

**Standard:** S13  
**Soft-close:** S18

Note: Gold and Brushed Nickel seat hinges are not compatible with the above seats.



Our WC seats match our furniture.  
See page 100 for the full range.



Seat handles  
(Sold in pairs)

**Chrome:** A51 CHR  
**Gold:** A51 GOLD  
**Br. Nickel:** A51 BNKL



Wooden seat hinges  
(Seats supplied with Chrome hinges)

**Gold:** SP813  
**Br. Nickel:** SP813 BNKL

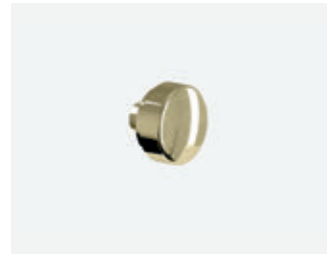

Gold cover caps for WCs  
(Sold in pairs)

**Code:** SP387



Ceramic trap for converting  
P trap to S trap

**Code:** C26



Straight ceramic trap

**Code:** C29

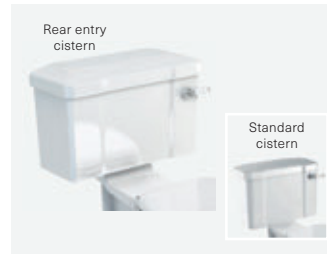

Back entry 520mm deep  
lever cistern

**Code:** C30

### WC Rear Entry Options

Burlington cisterns are available with either bottom or back entry filling for flexible installation.

If you need to fill your cistern from the back, you will need to order a C30.

(This deep cistern increases the distance from pan outlet to the wall by 20mm)

## FLUSH OPTIONS

Our feature cistern levers are available in Gold or Brushed Nickel and create the perfect finishing touch. They work beautifully with our other feature options such as WC seats, brassware and accessories.



### Gold Lever

To add a Gold Lever please order a SP390 GOLD.

### Gold Dual Flush Lever

Available for our high level toilets only (not available on C28S cisterns)

**Code:** SP391 GOLD



### Brushed Nickel Lever

To add a Brushed Nickel Lever please order a SP390 BNKL.

### Brushed Nickel Dual Flush Lever

Available for our high level toilets only (not available on C28S cisterns)

**Code:** SP391 BNKL



### Gold Flush Pipes

Available for our low level and high level toilets only.

**Low Level:** T31 GOLD

**High Level:** T30 GOLD



### Brushed Nickel Flush Pipes

Available for our low level and high level toilets only.

**Low Level:** T31 BNKL

**High Level:** T30 BNKL

# RIVIERA

---

## Riviera Close Coupled Open Back WC

### Close Coupled Open Back

**W:** 357 **D:** 660 **H:** 820

**Codes:** RIV9 + RIV11 + RIV.025

Includes Chrome lever  
and seat.

---

## Riviera Close Couple Full Back To Wall WC

### Close Coupled Back to Wall

**W:** 357 **D:** 660 **H:** 820

**Codes:** RIV10 + RIV11 + RIV.025

Includes Chrome lever  
and seat.

---

## Riviera Back to Wall WC

### Back to Wall

**W:** 359 **D:** 535 **H:** 420

**Codes:** RIV12 + RIV.025

Includes seat.





## Riviera Wall Hung WC

### Wall Hung

**W:** 359 **D:** 535 **H:** 420

**Codes:** RIV13 + RIV.025

Concealed Cistern including Lever

**Chrome:** F6CC RIVCP

**Gold:** F6CC RIVGP

Includes seat.

## FINISHING OPTIONS

Gold finish toilet seat hinges, cistern levers and cover caps are available.

The cisterns and seats are supplied with Chrome as standard, simply add the option of Gold to match with the brassware.

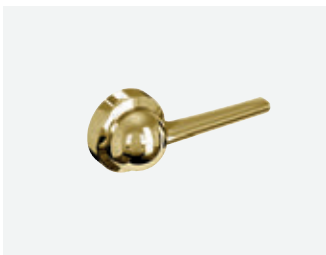

### Gold Lever

To add a Gold Lever please order a ARCSP6 GOLD.



### Riviera Soft Close Seat

**Seat with Chrome:** RIV.025

**Gold Hinges:** RIV.030

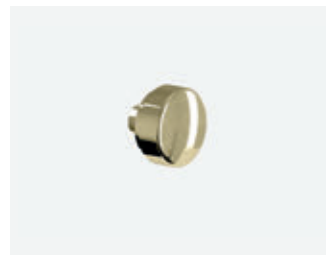

Gold cover caps for WCs  
(Sold in pairs)

**Code:** SP387

For full details on our WC ranges go to [burlingtonbathrooms.com/guides/toilets](http://burlingtonbathrooms.com/guides/toilets)

# BASINS

From large double basins to compact cloakroom options, Burlington offers a wide range of basins with many styles and sizes perfectly formed to suit your traditional bathroom.

---

## STYLE OPTIONS

Burlington has a wide range of Basin options. Select your style below.

### Classic



The Classic collection from Burlington is beautifully formed, available in rectangular or square designs, complete with an invisible waste option.

### Edwardian



The Edwardian collection is the ultimate in traditional bathrooms with structured corners and angular designs, the feel is unapologetic and proud.

### Victorian



Delicate and refined, the simplicity of this basin is stunning whilst its versatility allows you to continue the style through your home and brings an air of luxury.

### Contemporary



As the name suggests, the Contemporary collection is styled on the elegance of past times but with a modern day twist. Simplistic, structured lines form the basis for this striking ceramic collection.

### Contemporary Upstands



The Contemporary Upstand collection offers a classic structured look with a modern twist, combining a classic upstand with the clean lines of a contemporary basin.

### Cloakroom



A choice of traditionally designed cloakroom basins to achieve a consistent look throughout the home.

# BASINS

## ADDITIONS

Some of our washstands have the option to add additional features including a towel rack or rail.



Towel Rails



Towel Racks

## REGAL

Burlington Regal pedestals and washstands are higher than standard, making them more comfortable for taller people, the elderly or those prone to back pain.

	Standard	Regal
Classic	860mm	920mm
Victorian	840mm	900mm
Edwardian	840mm	900mm
Contemporary	840mm	900mm
Washstands	840mm	900mm



## GUARANTEES

\*The lifetime guarantee is subject to online registration and represents the perceived lifetime of the product which is 25 years. For full details on guarantees please visit [burlingtonbathrooms.com/guarantee](http://burlingtonbathrooms.com/guarantee).

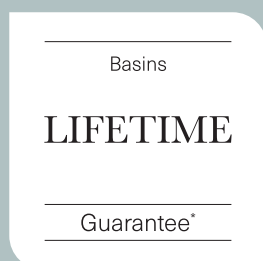

84

CLASSIC

86

EDWARDIAN

88

VICTORIAN

89

CONTEMPORARY

90

CONTEMPORARY UPSTANDS

92

NATURAL STONE

94

CLOAKROOM

95

ARCADE

96

RIVIERA

# CLASSIC BASINS



Classic 510mm Square Basin

**With Washstand**

**W:** 510 **D:** 450 **H:** 890

**Chrome:** B20\* + T52 CHR

**Gold:** B20\* + T52 GOLD

**Br. Nickel:** B20\* + T52 BNKL

Available with a Regal washstand. See page 89 for more details.



Classic 650mm Rectangular Basin

**With Washstand**

**W:** 650 **D:** 575 **H:** 830

**Chrome:** B15\* + T49A CHR

**Gold:** B15\* + T49A GOLD

**Br. Nickel:** B15\* + T49A BNKL

**With Pedestal**

**W:** 650 **D:** 575 **H:** 860

**Codes:** B15\* + P6

Available with a Regal washstand. See page 89 for more details.



Classic 650mm Rectangular Basin with Invisible Overflow

**With Chrome Washstand**

**W:** 650 **D:** 575 **H:** 860

**Codes:** B14 2TH + T49A CHR

**Invisible Overflow & Waste**

**W:** 74 **D:** 74 **H:** 300

**Code:** W9



**With Pedestal**

**W:** 650 **D:** 575 **H:** 860

**Codes:** B14 2TH + P6

Available with a Regal washstand. See page 89 for more details.

\* Available with 1, 2 or 3 tap holes. To order the correct basin configuration replace \* with 1TH, 2TH or 3TH.

Our washstands are now also available in a Gold or Brushed Nickel finish.



## INVISIBLE OVERFLOW WASTE

Available with the Classic collection as a two tap hole configuration. The benefit of invisible overflow is that the ceramic of the beautiful basins is un-interrupted with no requirement for a plug or external waste. Simply pull the lever to drain water. Pair with the elegant and beautiful Arch basin mixer allowing you to mix hot and cold water. See page 36 for an example.

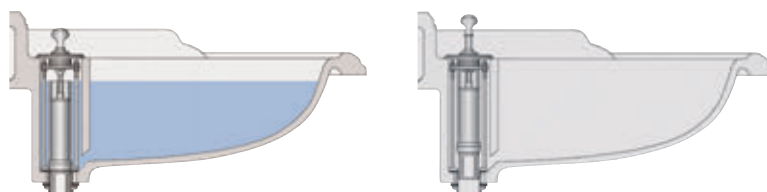

For full details on our basin ranges go to [burlingtonbathrooms.com/guides/basins](http://burlingtonbathrooms.com/guides/basins)

# EDWARDIAN BASINS



## Edwardian 560mm Rectangular Basin

### With Washstand

**W:** 560 **D:** 470 **H:** 840

**Chrome:** B4\* + T22A CHR

**Gold:** B4\* + T22A GOLD

**Br. Nickel:** B4\* + T22A BNKL

### With Pedestal

**W:** 560 **D:** 470 **H:** 840

**Codes:** B4\* + P1

### With Semi Pedestal

**W:** 560 **D:** 470 **H:** 840

**Codes:** B4\*\* + P8

Available with a Regal washstand/pedestal. See page 89 for more details.



## Edwardian 610mm Rectangular Basin

### With Washstand

**W:** 610 **D:** 510 **H:** 840

**Chrome:** B5\* + T23A CHR

**Gold:** B5\* + T23A GOLD

**Br. Nickel:** B5\* + T23A BNKL

### With Pedestal

**W:** 610 **D:** 510 **H:** 840

**Codes:** B5\* + P1

### With Semi Pedestal

**W:** 610 **D:** 510 **H:** 840

**Codes:** B5\*\* + P8

Available with a Regal washstand/pedestal. See page 89 for more details.



## Edwardian 800mm Rectangular Basin

### With Washstand

**W:** 800 **D:** 510 **H:** 840

**Chrome:** B18\* + T50 CHR

**Gold:** B18\* + T50 GOLD

**Br. Nickel:** B18\* + T50 BNKL

### With Pedestal

**W:** 800 **D:** 510 **H:** 840

**Codes:** B18\* + P6

Available with a Regal washstand. See page 89 for more details.

\* Available with 1, 2 or 3 tap holes. To order the correct basin configuration replace \* with 1TH, 2TH or 3TH.  
 \*\* 3TH is not available with semi pedestals



Our washstands are now also available in a Gold or Brushed Nickel finish.



### Edwardian 1200mm Rectangular Basin

**With Washstand**

**W:** 1200 **D:** 510 **H:** 840

**Chrome:** B19\* + T51 CHR

**Gold:** B19\* + T51 GOLD

**Br. Nickel:** B19\* + T51 BNKL

**With Pedestal**

**W:** 1200 **D:** 510 **H:** 840

**Codes:** B19\* + P6

Available with a Regal washstand. See page 89 for more details.



### Edwardian 1200mm Double Rectangular Basin

**With Washstand**

**W:** 1200 **D:** 510 **H:** 840

**Chrome:** B21\* + T51 CHR

**Gold:** B21\* + T51 GOLD

**Br. Nickel:** B21\* + T51 BNKL

Available with a Regal washstand. See page 89 for more details.



### Edwardian 560mm Round Basin

**With Washstand**

**W:** 560 **D:** 470 **H:** 840

**Chrome:** B6\* + T24A CHR

**Gold:** B6\* + T24A GOLD

**Br. Nickel:** B6\* + T24A BNKL

**With Pedestal**

**W:** 560 **D:** 470 **H:** 840

**Codes:** B6\* + P1

Also available with an optional towel rail. See page 88 for more information.

Available with a Regal washstand. See page 89 for more details.

# VICTORIAN BASINS



Victorian 560mm Rectangular Basin

**With Washstand**

**W:** 560 **D:** 470 **H:** 840

**Chrome:** B2\* + T22A CHR

**Gold:** B2\* + T22A GOLD

**Br. Nickel:** B2\* + T22A BNKL

**With Pedestal**

**W:** 560 **D:** 470 **H:** 840

**Codes:** B2\* + P1

**With Semi Pedestal**

**W:** 560 **D:** 470 **H:** 840

**Codes:** B2\*\* + P8

Available with a Regal washstand/pedestal. See right hand side for more details.



Victorian 610mm Rectangular Basin

**With Washstand**

**W:** 610 **D:** 510 **H:** 840

**Chrome:** B3\* + T23A CHR

**Gold:** B3\* + T23A GOLD

**Br. Nickel:** B3\* + T23A BNKL

**With Pedestal**

**W:** 610 **D:** 510 **H:** 840

**Codes:** B3\* + P1

**With Semi Pedestal**

**W:** 610 **D:** 510 **H:** 840

**Codes:** B3\*\* + P8

Available with a Regal washstand/pedestal. See right hand side for more details.

## ADDITIONAL CHOICES

Optional towel racks and rails are available for adding extra storage or space for towels in your bathroom. Towel racks are only compatible with washstands T22A and T23A. Towel rails can be added to Victorian, Edwardian and Contemporary Upstand basins.

### Towel Rails

**Rectangular Basins**  
**560 Basin:** T1 CHR  
**610 Basin:** T3 CHR

**Round Basins**  
**560 Basin:** T4 CHR



### Towel Racks

**For 560mm and 580mm Washstands**  
**Chrome:** T22A-S  
**Gold:** T22A-S GOLD  
**Br. Nickel:** T22A-S BNKL

**For 610mm Washstands**  
**Chrome:** T23A-S  
**Gold:** T23A-S GOLD  
**Br. Nickel:** T23A-S BNKL



\* Available with 1, 2 or 3 tap holes. To order the correct basin configuration replace \* with 1TH, 2TH or 3TH.  
 \*\* 3TH is not available with semi pedestals

# CONTEMPORARY BASINS



## Contemporary 580mm Rectangular Basin

### With Washstand

**W:** 580 **D:** 470 **H:** 840

**Chrome:** B1\* + T22A CHR

**Gold:** B1\* + T22A GOLD

**Br. Nickel:** B1\* + T22A BNKL

### With Pedestal

**W:** 580 **D:** 470 **H:** 840

**Codes:** B1\* + P1

### With Semi Pedestal

**W:** 580 **D:** 470 **H:** 840

**Codes:** B1\*\* + P8

Available with a Regal washstand/pedestal. See below for more details.



## Semi-recessed Basins

### 540 Countertop

**W:** 540 **D:** 425

**Code:** B13\*

### 580 Semi-recessed

**W:** 575 **D:** 470

**Code:** B12\*

# REGAL OPTIONS

Burlington Regal pedestals and washstands are higher than standard, making them more comfortable for taller people, the elderly or those prone to back pain.

## Washstands

To order a regal washstand choose from a T62, T62 GOLD or a T62 BNKL depending on the chosen finish of your washstand.

**Chrome**  
**Code:** T62

**Gold**  
**Code:** T62 GOLD

**Br. Nickel**  
**Code:** T62 BNKL

## Pedestals

To order a regal pedestal select a P9. The Regal pedestal is compatible with the B1, B2, B3, B4, B5 and B6 basins only.

**Regal Pedestal**  
**Code:** P9

For full details on our basin ranges go to [burlingtonbathrooms.com/guides/basins](http://burlingtonbathrooms.com/guides/basins)

# CONTEMPORARY UPSTAND BASINS



Contemporary Upstand 560mm Rectangular Basin

**With Washstand**

**W:** 560 **D:** 470 **H:** 840

**Chrome:** B1 UP\* + T22A CHR

**Gold:** B1 UP\* + T22A GOLD

**Br. Nickel:** B1 UP\* + T22A BNKL

**With Pedestal**

**W:** 560 **D:** 470 **H:** 840

**Codes:** B1 UP\* + P1

Available with a Regal washstand/pedestal. See page 89 for more details.



Contemporary Upstand 610mm Rectangular Basin

**With Washstand**

**W:** 610 **D:** 510 **H:** 840

**Chrome:** B2 UP\* + T23A CHR

**Gold:** B2 UP\* + T23A GOLD

**Br. Nickel:** B2 UP\* + T23A BNKL

**With Pedestal**

**W:** 610 **D:** 510 **H:** 840

**Codes:** B2 UP\* + P1

Available with a Regal washstand/pedestal. See page 89 for more details.

## ADDITIONAL CHOICES

Optional towel racks and rails are available for adding extra storage or space for towels in your bathroom. Towel racks are only compatible with washstands T22A and T23A. Towel rails can be added to Victorian, Edwardian and Contemporary Upstand basins.

### Towel Rails

**Rectangular Basins**  
**560 Basin:** T1 CHR  
**610 Basin:** T3 CHR

**Round Basins**  
**560 Basin:** T4 CHR



### Towel Racks

**For 560mm and 580mm Washstands**  
**Chrome:** T22A-S  
**Gold:** T22A-S GOLD  
**Br. Nickel:** T22A-S BNKL

**For 610mm Washstands**  
**Chrome:** T23A-S  
**Gold:** T23A-S GOLD  
**Br. Nickel:** T23A-S BNKL



\* Available with 1, 2 or 3 tap holes. To order the correct basin configuration replace \* with 1TH, 2TH or 3TH.  
 \*\* 3TH is not available with semi pedestals

Our washstands are now also available in a Gold or Brushed Nickel finish.



For full details on our basin ranges go to [burlingtonbathrooms.com/guides/basins](https://burlingtonbathrooms.com/guides/basins)

# NATURAL STONE BASINS



---

## Natural Stone Small 550mm Rectangular Basin

### With Stainless Steel Washstand

**W:** 550 **D:** 470 **H:** 880

**Codes:** B7E\* + B7ES

### Upstand Basin with Stainless Steel Washstand

**W:** 550 **D:** 470 **H:** 880

**Codes:** B7E UPS + B7ES

This can also be wall mounted but will require basin brackets:

**Codes:** B7E UPS + TZJ.550

This upstand basin is designed to work with Riviera wall mounted basin mixers only.



---

## Natural Stone Medium 650mm Rectangular Basin

### With Stainless Steel Washstand

**W:** 650 **D:** 470 **H:** 880

**Codes:** B8E\* + B8ES

### Upstand Basin with Stainless Steel Washstand

**W:** 650 **D:** 470 **H:** 880

**Codes:** B8E UPS + B8ES

This can also be wall mounted but will require basin brackets:

**Codes:** B8E UPS + TZJ.650



---

## Natural Stone Large 750mm Rectangular Basin

### With Stainless Steel Washstand

**W:** 750 **D:** 470 **H:** 880

**Chrome:** B9E\* + B9ES

\* Available with 1, 2 or 3 tap holes. To order the correct basin configuration replace \* with 1TH, 2TH or 3TH.

These basins can also be paired with our Chalfont furniture. See page 108 for details.



Natural Stone Double 1000mm Rectangular Basin

With Stainless Steel  
Washstand

W: 1000 D: 470 H: 880

Codes: B10DE\* + B10ES



For full details on our basin ranges go to [burlingtonbathrooms.com/guides/basins](https://burlingtonbathrooms.com/guides/basins)

# CLOAKROOM BASINS



Edwardian Cloakroom 515mm Basin  
with Washstands

**With Washstand**

**W:** 515 **D:** 308 **H:** 825

**Chrome:** B8\* + T21A CHR

**Gold:** B8\* + T21A GOLD

**Br. Nickel:** B8\* + T21A BNKL

Available with a Regal washstand. See below for more details.



Edwardian

Curved

Arcade

Corner

## Cloakroom Basins

**Edwardian 515**

**W:** 515 **D:** 308

**Code:** B8\*

**Curved 505**

**W:** 505 **D:** 255

**Code:** P13\*

**Arcade 500**

**W:** 500 **D:** 400

**Code:** ARC500\*

**Corner 600**

**W:** 600 **D:** 450

**Code:** B10

# REGAL OPTIONS

Burlington Regal pedestals and washstands are higher than standard, making them more comfortable for taller people, the elderly or those prone to back pain.

### Washstands

To order a regal washstand choose from a T62, T62 GOLD or a T62 BNKL depending on the chosen finish of your washstand.

**Chrome**  
**Code:** T62

**Gold**  
**Code:** T62 GOLD

**Br. Nickel**  
**Code:** T62 BNKL

### Pedestals

To order a regal pedestal select a P9. The Regal pedestal is compatible with the B1, B2, B3, B4, B5 and B6 basins only.

**Regal Pedestal**  
**Code:** P9

For full details on our basin ranges go to [burlingtonbathrooms.com/guides/basins](http://burlingtonbathrooms.com/guides/basins)

\* Available with 1, 2 or 3 tap holes. To order the correct basin configuration replace \* with 1TH, 2TH or 3TH.



# ARCADE BASINS



---

Arcade 600mm Basin

**With Pedestal**

**W:** 605 **D:** 525 **H:** 840

**Codes:** ARC600\* + ARC1

\* Only available as NTH, 1TH and 3TH whilst stock lasts



---

Arcade 900mm Basin

**With Pedestal**

**W:** 905 **D:** 550 **H:** 840

**Code:** ARC900 3TH + ARC1

Whilst stock lasts



---

Arcade 1200mm Double Basin

**With Chrome Washstand**

**W:** 1215 **D:** 560 **H:** 840

**Codes:** ARC1200\* + ARC24 CHR

**With Legs**

**W:** 1215 **D:** 560 **H:** 840

**Codes:** ARC1200\* + ARC2

\* Available with 0, 1, 2 or 3 tap holes. To order the correct basin configuration replace \* with NTH, 1TH, 2TH or 3TH.

# RIVIERA BASINS



Riviera 580mm D Shaped Basin

**With Pedestal**

**W:** 580 **D:** 470 **H:** 847

**Codes:** RIV3\* + RIV6

**With Semi Pedestal**

**W:** 580 **D:** 470 **H:** 847

**Codes:** RIV3\* + RIV7



Riviera 650mm D Shaped Basin

**With Pedestal**

**W:** 650 **D:** 470 **H:** 847

**Codes:** RIV4\* + RIV6

**With Semi Pedestal**

**W:** 650 **D:** 470 **H:** 847

**Codes:** RIV4\* + RIV7



Riviera Semi-recessed

**580 Semi-recessed**

**W:** 580 **D:** 470

**Codes:** RIV5\*

\* Available with 1, 2 or 3 tap holes. To order the correct basin configuration replace \* with 1TH, 2TH or 3TH.

---

Riviera 580mm Square Shaped Basin

**With Pedestal**

**W:** 580 **D:** 470 **H:** 847

**Codes:** RIV1\* + RIV6

**With Semi Pedestal**

**W:** 580 **D:** 470 **H:** 847

**Codes:** RIV1\* + RIV7



---

Riviera 650mm Square Shaped Basin

**With Pedestal**

**W:** 650 **D:** 470 **H:** 847

**Codes:** RIV2\* + RIV6

**With Semi Pedestal**

**W:** 650 **D:** 470 **H:** 847

**Codes:** RIV2\* + RIV7



---

Riviera Cloakroom Basin

**450 Square Cloakroom**

**W:** 450 **D:** 320

**Codes:** RIV8 2TH



The Cloakroom basin is 2 taphole only and is not designed for use with either pedestal.

# FURNITURE

A range of beautifully traditional furniture solutions to add classic style and sophisticated British elegance to your bathroom. Choose from freestanding in either square or curved design, cloakroom or fully fitted options to create the most functional space to suit your individual needs.

## KEY FEATURES

Our furniture solutions are made from the finest materials and offer innovative features and smart details. Perfectly suited for the bathroom environment.



Freestanding



Chalfont



Riviera



The plinths of the freestanding furniture are crafted from a waterproof high density material - providing extra protection and giving peace of mind that wet floors will not lead to damage.



Available in 4 sizes and 3 colours with the design option to have wall hung or floor standing by using additional legs available in wood with matching paint finishes or in brass with a Chrome, Gold or Nickel finish to compliment the Burlington brassware ranges.



Available as floor-standing in 2 sizes and 3 colours with matching handles available in Chrome or Gold finishes.



Each of our Classic furniture pieces are prepared with 5 layers of primer featuring UV stabilisation to minimise colour fading from exposure to sunlight. The painted top coat is then applied for a glorious depth of colour.



All of our Chalfont furniture pieces have a high quality paint finish and are prepared with 3 layers of primer featuring UV stabilisation to minimise colour fading from exposure to sunlight. Followed by 2 layers of top coat for a glorious depth of colour.



Made from materials specifically selected to withstand the rigours of life in the bathroom where temperature and humidity can vary widely.



Unlike conventional fitted furniture, our units offer full floor to height storage providing increased space for all your bathroom cosmetics and accessories.



Chalfont furniture units pair exclusively with Burlington's natural stone roll top basins. Natural stone's beautiful and tactile appearance is also extremely hard wearing and minor scuffs and scrapes are, in most cases, easily polished and smoothed away. These basins are supplied undrilled for your preferred choice of 1, 2 or 3 tap holes.



Each part is coated with five layers of primer, before the final coating is applied; this top coat is UV-resistant to reduce the effects of exposure to bright sunlight.



Riviera vanity units are supplied fully assembled for simple installation, with adjustable feet to ensure stability and protect them from wet floors.

# FURNITURE

100  
CLOAKROOM

101  
FREESTANDING

104  
FITTED

105  
BATH

108  
CHALFONT

110  
RIVIERA

---

## GUARANTEES

\*For full details on guarantees please visit  
[burlingtonbathrooms.com/guarantee](http://burlingtonbathrooms.com/guarantee).

Furniture

10  
YEAR

Guarantee\*

# FREESTANDING FURNITURE



---

Edwardian 560mm Basin & Freestanding  
Rectangular Cloakroom Vanity Unit

**W:** 560 **D:** 470 **H:** 927

**Matt White:** FC12W + B4

**Classic Grey:** FC12G + B4

**Blue:** FC12B + B4

**Matt Green:** FC12MG + B4



---

Edwardian Cloakroom Basin & Freestanding  
Rectangular Cloakroom Vanity Unit

**W:** 512 **D:** 310 **H:** 905

**Matt White:** FC11W + B8

**Classic Grey:** FC11G + B8

**Blue:** FC11B + B8

**Matt Green:** FC11MG + B8



---

Corner Quattrocast Basin & Freestanding Corner  
Cloakroom Vanity Unit

**W:** 430 **D:** 430 **H:** 840

**Matt White:** FC7W + FC7BB

**Classic Grey:** FC7G + FC7BB

**Matt Green:** FC7MG + FC7BB

Right hand only.  
Handles are supplied fitted.

Chrome handles included with the furniture. To purchase alternative finishes please use the codes: **Br. Nickel:** A56 BNKL **Gold:** A56 GOLD



Classic 510mm Basin & Freestanding 500mm Square Cloakroom Vanity Unit

**W:** 510 **D:** 450 **H:** 915

**Matt White:** FC8W + B20

**Classic Grey:** FC8G + B20

**Blue:** FC8B + B20

**Matt Green:** FC8MG + B20



· NEW ·

Freestanding 750 Vanity Unit With Doors & Minerva® Worktops

**W:** 790 **D:** 550 **H:** 1000

**Matt White:** FC13W

**Classic Grey:** FC13G

**Blue:** FC13B

**Matt Green:** FC13MG

Now choose a worktop from the below



**White:** BW75



**Carrara White:** BC75

\*Please check the product to see the colours available.

# FREESTANDING FURNITURE



Freestanding 650 Vanity Unit & Classic 650 Basin  
for Standard Waste & Overflow

**With Doors**

**W:** 670 **D:** 580 **H:** 930

**Matt White:** FF8W + B15

**Classic Grey:** FF8G + B15

**Blue:** FF8B + B15

**Matt Green:** FF8MG + B15

**With Drawers**

**W:** 670 **D:** 580 **H:** 930

**Matt White:** FF9W + B15

**Classic Grey:** FF9G + B15

**Matt Green:** FF9MG + B15



Freestanding 650 Vanity Unit & Classic 650 Basin  
for Integrated Waste & Overflow

**With Doors**

**W:** 670 **D:** 580 **H:** 930

**Matt White:** FF8W + B14

**Classic Grey:** FF8G + B14

**Blue:** FF8B + B14

**Matt Green:** FF8MG + B14

**With Drawers**

**W:** 670 **D:** 580 **H:** 930

**Matt White:** FF9W + B14

**Classic Grey:** FF9G + B14

**Matt Green:** FF9MG + B14



Freestanding 650 Vanity Unit & Minerva®  
Worktops with Vanity Bowl

**With Doors**

**W:** 670 **D:** 580 **H:** 850-930

**Matt White:** FF8W

**Classic Grey:** FF8G

**Blue:** FF8B

**Matt Green:** FF8MG

**With Drawers**

**W:** 670 **D:** 580 **H:** 850-930

**Matt White:** FF9W

**Classic Grey:** FF9G

**Matt Green:** FF9MG

Now choose a worktop from the below



**White:** BW66



**Carrara White:** BC66

Chrome handles included with the furniture. To purchase alternative finishes please use the codes: **Br. Nickel:** A56 BNKL **Gold:** A56 GOLD





Freestanding 1300 Vanity Unit With Doors & Minerva® Worktops with Double Vanity Bowl

**With Doors**

**W:** 1300 **D:** 550 **H:** 850-930

**Matt White:** FC9W  
**Classic Grey:** FC9G  
**Blue:** FC9B  
**Matt Green:** FC9MG

**With Drawers**

**W:** 1300 **D:** 550 **H:** 850-930

**Matt White:** FC10W  
**Classic Grey:** FC10  
**Matt Green:** FC10MG

Now choose a worktop from the below



**White:** BW12



**Carrara White:** BC12



Freestanding 1340 Curved Vanity Unit With Doors & Minerva® Worktops with Vanity Bowl

**With Doors**

**W:** 1340 **D:** 550 **H:** 850-930

**Matt White:** FC1W  
**Classic Grey:** FC1G  
**Blue:** FC1B  
**Matt Green:** FC1MG

**With Drawers**

**W:** 1340 **D:** 550 **H:** 850-930

**Matt White:** FC4W  
**Classic Grey:** FC4G  
**Blue:** FC4B  
**Matt Green:** FC4MG

Now choose a worktop from the below



**White:** BW13



**Carrara White:** BC13



Freestanding 980 Curved Vanity Unit With Doors & Minerva® Worktops with Vanity Bowl

**Left Handed**

**W:** 980 **D:** 550 **H:** 850-930

**Matt White:** FC2W  
**Classic Grey:** FC2G  
**Blue:** FC2B  
**Matt Green:** FC2MG

**Right Handed**

**W:** 980 **D:** 550 **H:** 850-930

**Matt White:** FC3W  
**Classic Grey:** FC3G  
**Blue:** FC3B  
**Matt Green:** FC3MG

Now choose a worktop from the below



**White:**  
 BW98L/R



**Carrara White:**  
 BC98L/R

\*Please check the product to see the colours available.

# FITTED FURNITURE



---

## 1200 Minerva® Worktops

**Minerva® White**

**Code:** BW305

**Minerva® Carrara White**

**Code:** BC305

Other worktops available see page 106

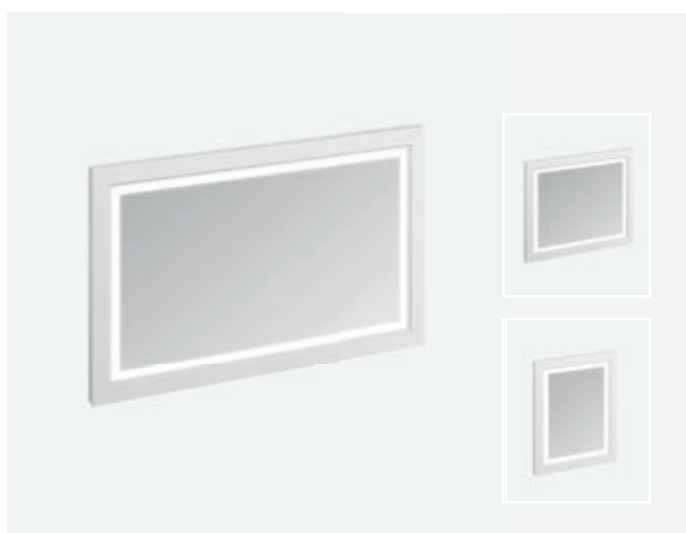

---

## Framed Mirror with LED Illuminations

**1200 Mirror**

**W:** 1200 **D:** 40 **H:** 750

**Matt White:** M12MW

**Classic Grey:** M12MG

**Blue:** M12MB

**Matt Green:** M12MMG

**900 Mirror**

**W:** 900 **D:** 40 **H:** 750

**Matt White:** M9MW

**Classic Grey:** M9MG

**Matt Green:** M9MMG

**600 Mirror**

**W:** 600 **D:** 40 **H:** 750

**Matt White:** M6MW

**Classic Grey:** M6MG

**Blue:** M6MB

**Matt Green:** M6MMG

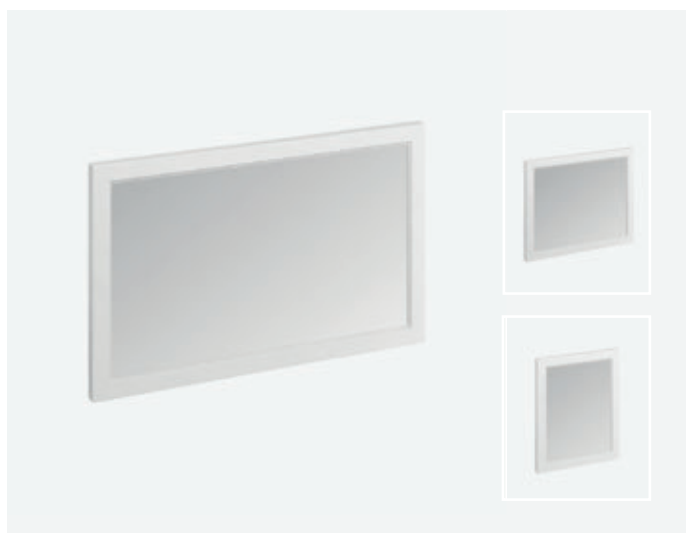

---

## Framed Mirror

**1200 Mirror**

**W:** 1200 **D:** 40 **H:** 750

**Matt White:** M12OW

**Classic Grey:** M12OG

**Matt Green:** M12OMG

**900 Mirror**

**W:** 900 **D:** 40 **H:** 750

**Matt White:** M9OW

**Classic Grey:** M9OG

**Matt Green:** M9OMG

**600 Mirror**

**W:** 600 **D:** 40 **H:** 750

**Matt White:** M6OW

**Classic Grey:** M6OG

**Matt Green:** M6OMG



### 600 Mirrored Cabinet

**W: 600 D: 152 H: 750**

**Matt White:** SM6015W

**Classic Grey:** SM6015G

**Blue:** SM6015B

**Matt Green:** SM6015MG



### Arundel Bath with Panels

**1700 x 700**

**W: 700 D: 1700 H: 595**

**Matt White:**

E28 + E24FW + E25EW

**Classic Grey:**

E28 + E24FG + E25EG

**Matt Green:**

E28 + E24FMG + E25EMG

**1700 x 750**

**W: 750 D: 1700 H: 595**

**Matt White:**

E30 + E24FW + E26EW

**Classic Grey:**

E30 + E24FG + E26EG

**Matt Green:**

E30 + E24FMG + E26EMG

\*Please check the product to see the colours available.

# MINERVA WORKTOPS

Minerva worktops offer superior strength with a beautiful finish. Available from stock in either White or Carrara White. Why not choose from our other 11 unique decor options, available to order with longer custom delivery times (4 - 5 weeks) for the ultimate personalised look. Please ask your retailer for details on the price of the 11 additional finishes.



White



Carrara White



Ice Blue



Desert Rock



Fossil



Peak Stone



Nimbus Grey



Amazonia Brown



Ice Crystal



Copper Fleck



Sparkling White



Caramel Crunch



Grey Crystal



Minerva® Care Kit

**Code:** BCARE



Minerva® Joint Kit

**White:** MVWH  
**Carrara White:** MVBG  
**Black Granite:** MVCA

## Minerva Basins

Minerva basins fit perfectly with your chosen furniture unit. Should you opt for a fitted furniture look, a Minerva worktop can be chosen to fit the length of your furniture units.

### Tap holes

Minerva® worktops are supplied with an integrated bowl with overflow, and no tap holes. Tap holes are drilled by the installer in the required position and configuration. A template is provided with the Minerva® tops indicating tap hole positions and sizes.

### Routine Cleaning

Minerva® does not require any specialist cleaning regimes, most dirt will easily wipe off with a damp cloth and soapy water. The work surface should then be rinsed with clean water and wiped dry. Persistent marks can be removed by using a mild abrasive cleaner, but harsh scouring powders should be avoided.

### Staining

Minerva®, unlike marble and granite, is not porous and will resist most household chemicals including alcohol and cosmetics, however, some chemicals and strong dyes can cause damage and discolouration. If spillage occurs, wipe off immediately and rinse the area thoroughly.

### Minerva® Care Kit

To restore your Minerva® work top to its original best use the Care Kit to buff out all tiny scratches and scuffs. The kit contains all the sanding / buffing materials and liquids required.

# PAINT YOUR OWN

Should you wish, our Matt White furniture is supplied ready for you to paint, so you can transform your entire bathroom into your individual colour scheme. We've chosen some Farrow & Ball colours as suggestions displayed below. We recommend using a water based primer before an egg shell paint finish for the best effect.



Brinjal



Incarnadine



Tanner's Brown



Red Earth



Cook's Blue



Cinder Rose



Oxford Stone



Dayroom Yellow

For full details on our furniture ranges go to [burlingtonbathrooms.com/guides/furniture](http://burlingtonbathrooms.com/guides/furniture)

# CHALFONT



## 550 Unit with Drawer & Natural Stone Small Roll Top Basin

### With Matching Legs

**W:** 525 **D:** 458 **H:** 840

### Matt Black:

CH55MB + B7E\* + CHLEGMB

### Classic Grey:

CH55G + B7E\* + CHLEGG

### Blue:

CH55B + B7E\* + CHLEGB

### Wall Hung

**W:** 525 **D:** 458 **H:** 840

### Matt Black:

CH55MB + B7E\*

### Classic Grey:

CH55G + B7E\*

### Blue:

CH55B + B7E\*

Also available with small roll top basin with up-stand. See page 90



## 650 Unit with Drawer & Natural Stone Medium Roll Top Basin

### With Matching Legs

**W:** 625 **D:** 458 **H:** 840

### Matt Black:

CH65MB + B8E\* + CHLEGMB

### Classic Grey:

CH65G + B8E\* + CHLEGG

### Blue:

CH65B + B8E\* + CHLEGB

### Wall Hung

**W:** 625 **D:** 458 **H:** 840

### Matt Black:

CH65MB + B8E\*

### Classic Grey:

CH65G + B8E\*

### Blue:

CH65B + B8E\*

Also available with medium roll top basin with up-stand. See page 90



## 750 Unit with Drawer & Natural Stone Large Roll Top Basin

### With Matching Legs

**W:** 725 **D:** 458 **H:** 840

### Matt Black:

CH75MB + B9E\* + CHLEGMB

### Classic Grey:

CH75G + B9E\* + CHLEGG

### Blue:

CH75B + B9E\* + CHLEGB

### Wall Hung

**W:** 725 **D:** 458 **H:** 840

### Matt Black:

CH75MB + B9E\*

### Classic Grey:

CH75G + B9E\*

### Blue:

CH75B + B9E\*

\* Supplied undrilled for your preferred choice of 0, 1, 2 or 3 taphole. Tap holes are drilled by the installer in the required position and configuration.



1000 Unit with Drawer & Natural Stone  
Double Roll Top Basin

**With Matching Legs**

W: 525 D: 458 H: 840

**Matt Black:**

CH100MB + B10DE\* + CHLEGMB

**Classic Grey:**

CH100G + B10DE\* + CHLEGG

**Blue:**

CH100B + B10DE\* + CHLEGB

**Wall Hung**

W: 525 D: 458 H: 840

**Matt Black:**

CH100MB + B10DE\*

**Classic Grey:**

CH100G + B10DE\*

**Blue:**

CH100B + B10DE\*

## ADDITIONAL CHOICES

Our Chalfont furniture range is supplied without legs or handles allowing you to fully customise your furniture to the look you desire. To add these, please select from the options below.



### Handles

Our beautiful matching handles are available in 3 finishes allowing you to match your brassware and furniture unit perfectly. Use the codes below to order. Please note these are sold as singles.

**Chrome:** CHKCHR

**Gold:** CHKGOLD

**Br. Nickel:** CHKBNKL



### Additional Legs

As well as having legs in the matching furniture colour we also offer 3 additional finishes with a slightly different design which are sold in pairs. If you would like these legs instead please use the codes below:

**Chrome:** CHLEGCHR

**Gold:** CHLEGGOLD

**Br. Nickel:** CHLEGBNKL



For full details on our Chalfont range go to [burlingtonbathrooms.com/collection/chalfont](http://burlingtonbathrooms.com/collection/chalfont)

# RIVIERA



580 Riviera Unit with Basin

## 580 Vanity Unit

**W:** 580 **D:** 470 **H:** 880

**Matt White:**  
RIVF580W + RIV1\*

**Matt Blue:**  
RIVF580B + RIV1\*

**Matt Pink:**  
RIVF580P + RIV1\*

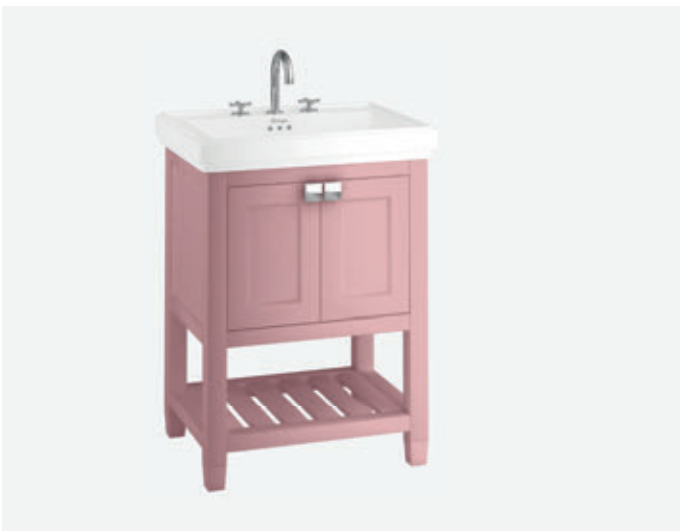

650 Riviera Unit with Basin

## 650 Vanity Unit

**W:** 650 **D:** 470 **H:** 880

**Matt White:**  
RIVF650W + RIV2\*

**Matt Blue:**  
RIVF650B + RIV2\*

**Matt Pink:**  
RIVF650P + RIV2\*

## ADDITIONAL CHOICES

Our Chalfont furniture range is supplied with Chrome handles, we also have Gold as an option allowing you to fully customise your furniture to the look you desire. To add these, please order the code below.

For full details on our Riviera range go to  
[burlingtonbathrooms.com/riviera](http://burlingtonbathrooms.com/riviera)

### Handles

Please note these are sold as a set of 2.

**Gold:** RIVF 11







# BATHS

Beautiful freestanding baths in a range of designs crafted with either TSFR (twin skinned fibre re-inforced acrylic) for superior strength or ClearStone for the epitome of luxury. Choose from soaking tubs, elegant roll top baths, single or double-ended or showering baths for flexibility of use.

---

## BATH FEET

Choose from five leg designs in three finishes on page 121.



Claw



Arc



Classic



Traditional



Classical

---

## PAINTING YOUR BATH

The exterior can be primed and painted. If you wish to paint yours then please note this is only possible on TSFR baths. You should seek advice from the paint manufacturer for suitable primers and processes.



# BATHS

114  
FREESTANDING

120  
SHOWERING

121  
ACCESSORIES

---

## GUARANTEES

\*For full details on guarantees please visit  
[burlingtonbathrooms.com/guarantee](http://burlingtonbathrooms.com/guarantee).





# BALTHAZAR

Double Ended Bath

L: 1675 W: 761 H: 711

Stainless Steel: N25CS

**Weight empty**

111kg

**Displaced capacity**

164L

**Material**

Clearstone

**Tap hole options**

Not suitable for rim-mounted taps

**Overflow**

Pre-drilled

**Compatible wastes**

CW3, CW11



# ADMIRAL

Double Ended Bath

**1650 Bath**

L: 1640 W: 705 H: 710

Code: ET5C

**1800 Bath**

L: 1775 W: 890 H: 750

Code: ET6C

**Weight empty**

1650 - 48kg

1800 - 60kg

**Displaced capacity**

1650 - 99L

1800 - 175L

**Material**

Acrylic

**Tap hole options**

Not suitable for rim-mounted taps

**Overflow**

Pre-drilled

**Compatible wastes**

CW3, W4, CW6



---

## BRINDLEY

Double Ended Bath

**1700 Bath**

L: 1700 W: 750 H: 620

**Code:** E5.E12

**Weight empty**

36kg

**Displaced capacity**

180L

**Material**

Acrylic

**Tap hole options**

Not suitable for  
rim-mounted taps

**Overflow**

Supplied with  
template, undrilled

**Compatible wastes**

CW2, W3



---

## LONDON ROUND

Double Ended Bath

**1800 Bath**

L: 1800 W: 850 H: 640

**Code:** E18

**Weight empty**

52kg

**Displaced capacity**

200L

**Material**

Acrylic

**Tap hole options**

Not suitable for  
rim-mounted taps

**Overflow**

Pre-drilled

**Compatible wastes**

Pre fitted



# ARUNDEL

Single Ended

## 700 Bath

L: 1700 W: 700 H: 580

Code: E28

## 750 Bath

L: 1700 W: 750 H: 580

Code: E30

## 700 End Panels

W: 700 H: 540

700: E25E\*

## 750 End Panels

W: 750 H: 540

750: E26E\*

## Side Panel

L: 1700 H: 540

Code: E24F\*

Replace \* with either W/G/MG depending on what colour panels you would like.

### Weight empty

700 - 24kg

750 - 25kg

### Displaced capacity

700 - 108L

750 - 125L

### Material

Acrylic with  
Cleargreen  
reinforcement

### Tap hole options

Undrilled

### Overflow

Pre-drilled

### Compatible wastes

W3

### Compatible

bathscreens  
C9, C10



# ARUNDEL

Double Ended

## 700 Bath

L: 1700 W: 700 H: 580

Code: E31

## 750 Bath

L: 1700 W: 750 H: 580

Code: E32

## 700 End Panels

W: 700 H: 540

700: E25E\*

## 750 End Panels

W: 750 H: 540

750: E26E\*

## Side Panel

L: 1700 H: 540

Code: E24F\*

Replace \* with either W/G/MG depending on what colour panels you would like.

### Weight empty

700 - 24kg

750 - 25kg

### Displaced capacity

700 - 108L

750 - 125L

### Material

Acrylic with  
Cleargreen  
reinforcement

### Tap hole options

Undrilled

### Overflow

Pre-drilled

### Compatible wastes

W3

### Compatible

bathscreens  
C9, C10



# EMPEROR

Slipper Bath

**1500 Bath**

**L: 1530 W: 725 H: 780**

**Code: ET13B**

**Weight empty**

38kg

**Displaced capacity**

242L

**Material**

Acrylic

**Tap hole options**

Not suitable for rim-mounted taps

**Overflow**

Supplied with template, undrilled

**Compatible wastes**

CW2, CW3, W4, CW6, W21



# AVANTGARDE

Back to Wall Bath

**1700 Bath**

**L: 1700 W: 750 H: 630**

**Code: T12D**

**Feet - Shown With**

**Code: L2B**

**Weight empty**

43kg

**Displaced capacity**

158L

**Material**

TSFR Double Acrylic

**Tap hole options**

0, 1, 2 (supplied with template, undrilled)

**Overflow**

Supplied with template, undrilled

**Compatible wastes**

CW2, CW3, W4, CW6, W21

**Compatible feet**

See page 121



# BATEAU

Double Ended Bath

**1700 Bath**

**L:** 1640 **W:** 700 **H:** 720

**Code:** T10F

**Feet - Shown With**

**Code:** L2C

**Note**

The Bateau bath comes in a white finish. The exterior can be primed and painted. The photograph shows the bath in Fired Earth Carbon Blue. If you wish to paint yours then please note this is only possible on TSFR baths. You should seek advice from the paint manufacturer for suitable primers and processes.

**Weight empty**  
42kg

**Displaced capacity**  
169L

**Material**  
TSFR Double  
Acrylic

**Tap hole options**  
Not suitable for rim-mounted taps

**Overflow**  
Pre-drilled

**Compatible wastes**  
CW3, W4, CW6, W21

**Compatible feet**  
See page 121



# WINDSOR

Double Ended Bath

**1500 Bath**

**L:** 1500 **W:** 750 **H:** 630

**Code:** E4

**1700 Bath**

**L:** 1700 **W:** 750 **H:** 620

**Code:** E3

**Feet - Shown With**

**Code:** L1C

**Weight empty**  
1500 - 45kg  
1700 - 45kg

**Displaced capacity**  
1500 - 115L  
1700 - 130L

**Material**  
TSFR Double  
Acrylic

**Tap hole options**  
0, 1, 2 (supplied with template, undrilled)

**Overflow**  
Supplied with template, undrilled

**Compatible wastes**  
CW2, CW3, W4, W21

**Compatible feet**  
See page 121





# BUCKINGHAM

Slipper Bath

**1500 Bath**

**L: 1530 W: 740 H: 620**

**Code: E6**

**Feet - Shown With**

**Code: L2W**

**Weight empty**

39kg

**Displaced capacity**

85L

**Material**

TSFR Double  
Acrylic

**Tap hole options**

0, 1, 2 (supplied  
with template,  
undrilled)

**Overflow**

Supplied with  
template, undrilled

**Compatible wastes**

CW2, CW3, W4,  
W21

**Compatible feet**

See page 121



# HAREWOOD

Slipper Bath

**1700 Bath**

**L: 1690 W: 730 H: 770**

**Code: E1**

**Feet - Shown With**

**Code: E11 CHR**

**Weight empty**

48kg

**Displaced capacity**

125L

**Material**

TSFR Double  
Acrylic

**Tap hole options**

0, 1, 2 (supplied  
with template,  
undrilled)

**Overflow**

Supplied with  
template, undrilled

**Compatible wastes**

CW2, CW3, W4,  
W21

**Compatible feet**

See page 121



# BLENHEIM

Single Ended Bath

**1700 Bath**

L: 1690 W: 750 H: 640

**Code:** E2

**Feet - Shown With**

**Code:** E10 CHR

**Weight empty**  
45kg

**Displaced capacity**  
115L

**Material**  
TSFR Double  
Acrylic

**Tap hole options**  
0, 1, 2 (supplied  
with template,  
undrilled)

**Overflow**  
Supplied with  
template,  
undrilled

**Compatible wastes**  
CW2, CW3, W4,  
W21

**Compatible feet**  
See page 121



# HAMPTON

Showering Bath

**1500 Bath**

L: 1500 W: 750 H: 630

**Left Handed:** E20  
**Right Handed:** E21

**1700 Bath**

L: 1700 W: 750 H: 620

**Left Handed:** E13  
**Right Handed:** E14

**Feet - Shown With**

**Code:** L3C

**Weight empty**  
1500 - 37kg  
1700 - 46kg

**Displaced capacity**  
1500 - 105L  
1700 - 138L

**Material**  
TSFR double acrylic  
skin with solid core

**Tap hole options**  
0, 1, 2 (supplied  
with template,  
undrilled)

**Overflow**  
Supplied with  
template, undrilled

**Compatible wastes**  
W4

**Compatible  
bathscreens**  
C9, C10

**Compatible feet**  
See page 121



Claw Feet

**Chrome:** L1C  
**White:** L1W  
**Black:** L1B



Arc Feet

**Chrome:** L2C  
**White:** L2W  
**Black:** L2B



Classic Feet

**Chrome:** L3C  
**White:** L3W  
**Black:** L3B



Traditional Feet

**Chrome:** E11 CHR  
**White:** E11 WHI  
**Black:** E11 BLA

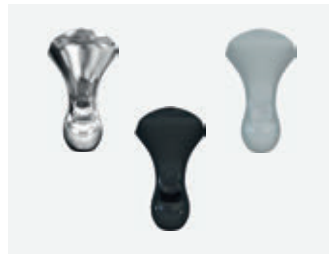

Classical Feet

**Chrome:** E10 CHR  
**White:** E10 WHI  
**Black:** E10 BLA



Stand pipes including horizontal support bar

**Chrome:** W7  
**Gold:** W7 GOLD  
**Br. Nickel:** W7 BNKL

These are for use with baths where fittings are not rim or wall-mounted. These can be used with deck-mounted taps (excluding Stafford).



Decorative shrouds

**Chrome:** W6  
**Gold:** W6 GOLD  
**Br. Nickel:** W6 BNKL

These are for use with baths with rim-mounted fittings and can be used with deck-mounted taps. Decorative only.



Single bathscreen

**W:** 850 **H:** 1450

**Code:** C9



Bathscreen with access panel

**W:** 850 **H:** 1450

**Code:** C10

# BRASSWARE

Burlington brassware can be customised with a choice of 4 tap heads; Claremont, Birkenhead, Anglesey and Kensington.

We supply every tap with two Neoperl devices: A flow straightener, which is for use with low water pressures and an aerator, which is for use with high water pressures.

---

## KEY FEATURES

Burlington brassware products have a range of key features across basin and bath taps, shown below.



### Swivelling Spouts

All our bath fillers and bath shower mixer spouts swivel - so you don't have the spout in your way when you shower.



### Angled Mixers

All our bath shower mixers are available in an 'angled' version.

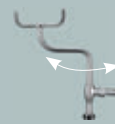

### S Adjuster

The S adjuster allows the telephone handset to be positioned over the bath. The bath shower mixer can be installed with or without the 'S adjuster'.

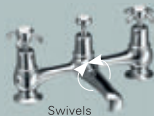

### Bridge Mixers

Our bridge basin mixer has a swivelling spout and allows you to have mixed hot & cold water, whilst using a two taphole configuration.



Normal

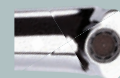

Burlington

### Spouts

Normal: The underside of a bath spout of a normal, traditional bath tap.  
Burlington: The underside of a Burlington bath tap with a Neoperl aerator.

---

## STYLE OPTIONS

Choose from a wide range of tap head options in finishes of either Chrome, Gold or Brushed Nickel.



Gold



Brushed Nickel



Claremont



Anglesey



Birkenhead



Kensington

# BRASSWARE

## REGENT

Our regent base can be used on all one, two and three tap hole taps (excluding Chelsea, Stafford and CL45-QT) offering an extra 30mm of height than the standard tap base and a further 30mm away from the wall when wall-mounted.

For the full range please visit the website.



Standard



Regent

## WATER PRESSURE

Our taps are designed to deliver the following maximum flows of water, regardless of the incoming water pressure:

Basin taps: 13L per minute

Bath tap: 14L per minute

Bath shower mixer: 22L per minute



### Normal tap

Water flow in a normal traditional tap.



### Low pressure

Low pressure water flow with a Burlington tap using a flow straightener.



### High pressure

High pressure water flow with a Burlington tap using an aerator.

## GUARANTEES

\*For full details on guarantees please visit [burlingtonbathrooms.com/guarantee](http://burlingtonbathrooms.com/guarantee).

Brassware

15  
YEAR

Guarantee\*

124

TRADITIONAL

126

THERMOSTATIC

126

STAFFORD

127

CHELSEA

128

RIVIERA

130

WASTES

# TRADITIONAL BASIN TAPS



Basin mixer with high central indice with click-clack waste

**Chrome:** CL6-QT  
**Gold:** CL6-QT GOLD  
**Br. Nickel:** CL6-QT BNKL

**Regent Option**  
**Chrome:** CLR6-QT  
**Gold:** CLR6-QT GOLD  
**Br. Nickel:** CLR6-QT BNKL



Basin mixer with high central indice with pop up waste

**Chrome:** CL4-QT  
**Gold:** CL4-QT GOLD  
**Br. Nickel:** CL4-QT BNKL

**Regent Option**  
**Chrome:** CLR4-QT  
**Gold:** CLR4-QT GOLD  
**Br. Nickel:** CLR4-QT BNKL



Basin mixer with high central indice with plug & chain waste

**Chrome:** CL5-QT  
**Regent Option**  
**Chrome:** CLR5-QT



Mono basin Mixer

**Chrome:** CL45-QT  
**Gold:** CL45-QT GOLD  
**Br. Nickel:** CL45-QT BNKL



Bidet mixer with high central indice with plug & chain waste

**Chrome:** CL13-QT  
**Regent Option**  
**Chrome:** CLR13-QT



Basin tap 3"

**Chrome:** CL1-QT  
**Gold:** CL1-QT GOLD  
**Br. Nickel:** CL1-QT BNKL

**Regent Option**  
**Chrome:** CLR1-QT  
**Gold:** CLR1-QT GOLD  
**Br. Nickel:** CLR1-QT BNKL



Basin tap 5"

**Chrome:** CL2-QT  
**Gold:** CL2-QT GOLD  
**Br. Nickel:** CL2-QT BNKL

**Regent Option**  
**Chrome:** CLR2-QT  
**Gold:** CLR2-QT GOLD  
**Br. Nickel:** CLR2-QT BNKL



Two tap hole bridge mixer with swivelling spout with plug & chain waste

**Chrome:** CL10-QT  
**Regent Option**  
**Chrome:** CLR10-QT



Two tap hole arch mixer with curved spout (200 centre)

**Chrome:** CL27-QT  
**Regent Option**  
**Chrome:** CLR27-QT



Two tap hole arch mixer with curved spout (230 centre)

**Chrome:** CL28-QT  
**Regent Option**  
**Chrome:** CLR28-QT



Three tap hole mixer with pop up waste

**Chrome:** CL12-QT  
**Gold:** CL12-QT GOLD  
**Br. Nickel:** CL12-QT BNKL

**Regent Option**  
**Chrome:** CLR12-QT  
**Gold:** CLR12-QT GOLD  
**Br. Nickel:** CLR12-QT BNKL

## Regent Options

Our regent base which can be used on all one, two and three tap hole taps (excluding Chelsea, Stafford and CL45-QT) offering an extra 30mm of height than the standard tap base and a further 30mm away from the wall when wall-mounted.

For the full range please visit the website.



For full details on our Brassware ranges go to [burlingtonbathrooms.com/guides/brassware](http://burlingtonbathrooms.com/guides/brassware)

# TRADITIONAL BATH TAPS



Bath shower mixer with 'S' adjuster deck-mounted

**Chrome:** CL15-QT  
**Gold:** CL15-QT GOLD  
**Br. Nickel:** CL15-QT BNKL  
**Regent Option**  
**Chrome:** CLR15-QT  
**Gold:** CLR15-QT GOLD  
**Br. Nickel:** CLR15-QT BNKL



Angled bath shower mixer with 'S' adjuster deck-mounted

**Chrome:** CL19-QT  
**Regent Option**  
**Chrome:** CLR19-QT



Bath filler deck-mounted

**Chrome:** CL23-QT  
**Regent Option**  
**Chrome:** CLR23-QT



Bath taps deck-mounted

**Chrome:** CL3-QT  
**Regent Option**  
**Chrome:** CLR3-QT



Bath shower mixer with 'S' adjuster wall-mounted

**Chrome:** CL17-QT  
**Gold:** CL17-QT GOLD  
**Br. Nickel:** CL17-QT BNKL  
**Regent Option**  
**Chrome:** CLR17-QT  
**Gold:** CLR17-QT GOLD  
**Br. Nickel:** CLR17-QT BNKL



Angled bath shower mixer with 'S' adjuster wall-mounted

**Chrome:** CL21-QT  
**Regent Option**  
**Chrome:** CLR21-QT

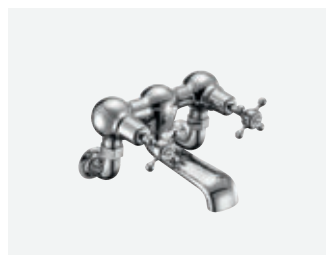

Bath filler wall-mounted

**Chrome:** CL24-QT  
**Regent Option**  
**Chrome:** CLR24-QT

## Finish Options

A collection of our brassware is available in 3 distinct finishes.

These can be matched across the whole of the Burlington collection to create your perfect bathroom.



# TAP HEAD OPTIONS

Choose from a wide range of tap head options in finishes of either Chrome, Gold or Brushed Nickel.

All our tap heads are available in Chrome as standard.

**Claremont:** The Claremont tap head is also available in Gold and Brushed Nickel.

**Kensington:** The Kensington tap head is available in Chrome only.

**Birkenhead:** The Birkenhead tap head is available in Chrome only.

**Anglesey:** The Anglesey tap head is available in Chrome only.

When ordering your **tap style** add the correct code to the start of the tap code:

Claremont add CL  
 Anglesey add AN  
 Birkenhead add BI  
 Kensington add KE

Examples:  
 CL6-QT  
 AN6-QT  
 BI6-QT  
 KE6-QT

To select an **alternative finish** add the below to the end of the code:  
 Gold add GOLD  
 Brushed Nickel add BNKL

Examples:  
 CL6-QT  
 CL6-QT GOLD  
 CL6-QT BNKL

Visit our website to view all the collections.



# THERMOSTATIC

Match your basin, bath and shower with the convenience and safety of thermostatic controls for your bathroom.



Three tap hole basin mixer with pop up waste

**Chrome:** CL29



Bath shower mixer deck-mounted with 'S' adjuster

**Chrome:** T2DB



Thermostatic two outlet twin control bath shower mixer valve

**Chrome Ceramic**

Deck: BT2DS+V16

Deck: BT2DS+V17

Deck: BT2DS+V60

## Safety

We use Vernet wax capsules throughout our thermostatic brassware and showering valves, meaning temperature when in use will not vary by more than + 1 degrees.

# STAFFORD

The Stafford collection cannot be paired with any other tap head options and is only available in quarter turn.



Stafford bath pillar taps

**Chrome:** STA13-QT



Stafford long nose basin pillar taps

**Chrome:** STA12-QT



Stafford mono basin mixer with pop up waste

**Chrome:** STA11-QT



Stafford bath shower mixer deck-mounted

**Chrome:** STA14-QT



# CHELSEA

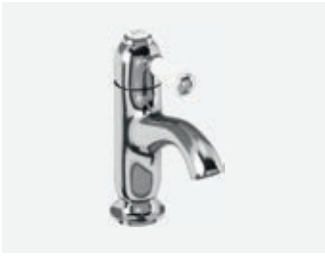

Curved basin mixer without waste

**Chrome:** CH21



Curved basin mixer with pop up waste

**Chrome:** CH22



Curved bidet mixer with pop up waste

**Chrome:** CH23



Straight basin mixer without waste

**Chrome:** CH19



Straight basin mixer with pop up waste

**Chrome:** CH20



Curved tall basin mixer without waste

**Chrome:** CHE2



Straight tall basin mixer without waste

**Chrome:** CHE1

## Unique Aesthetics

The Chelsea brassware range comes with its own unique, bespoke tap heads and are not available as Claremont, Anglesey or Birkenhead. Chelsea's range also comes with the choice of curved or straight spout.



For full details on our Brassware ranges go to [burlingtonbathrooms.com/guides/brassware](http://burlingtonbathrooms.com/guides/brassware)

# RIVIERA

## BASIN BRASSWARE



Basin mixer

**Chrome:** RIV8 CHR  
**Gold:** RIV8 GOLD



Basin pillar taps

**Chrome:** RIV7 CHR  
**Gold:** RIV7 GOLD



Three tap hole mixer

**Chrome:** RIV6 CHR  
**Gold:** RIV6 GOLD



Three hole basin mixer wall-mounted

**Chrome:** RS CHR  
**Gold:** RS GOLD

## BATH BRASSWARE



Deck-mounted panel valves

**Chrome:** RIV34 CHR  
**Gold:** RIV34 GOLD



Three tap hole bath mixer

**Chrome:** RIV32 CHR  
**Gold:** RIV32 GOLD



Four tap hole bath mixer

**Chrome:** RIV33 CHR  
**Gold:** RIV33 GOLD



Bath shower mixer with handset and hose

**Chrome:** RIV4 CHR  
**Gold:** RIV4 GOLD



Bath legs for bath shower mixer

**Chrome:** RIV15 CHR  
**Gold:** RIV15 GOLD



Overflow bath filler with click-clack waste

**Chrome:** RIV36 CHR  
**Gold:** RIV36 GOLD



Overflow bath filler extension kit

**Code:** RIV38

For the full Riviera range visit  
[burlingtonbathrooms.com/riviera](http://burlingtonbathrooms.com/riviera)



For full details on our Brassware ranges go to [burlingtonbathrooms.com/guides/brassware](http://burlingtonbathrooms.com/guides/brassware)

# WASTES



Shallow p trap

**Chrome:** CW3  
**Gold:** CW3 GOLD  
**Br. Nickel:** CW3 BNKL



Bath overflow plug & chain

**Chrome:** W3  
**Gold:** W3 GOLD  
**Br. Nickel:** W3 BNKL



Click clack bath waste (slotted) with chrome cover

**Code:** CW1



Click clack bath waste (unslotted) with chrome cover

**Code:** CW2



Special bath waste without a pre-drilled overflow hole

**Code:** CW11



Exposed bath overflow, click clack waste

**Code:** CW6



Exposed bath overflow, pug & chain

**Chrome:** W4  
**Gold:** W4 GOLD  
**Br. Nickel:** W4 BNKL



P trap connection pipe

**Chrome:** W21  
**Gold:** W21 GOLD  
**Br. Nickel:** W21 BNKL



Flip top basin waste, slotted

**Chrome:** W18  
**Gold:** W18 GOLD  
**Br. Nickel:** W18 BNKL



Click clack (push button) basin waste

**Chrome:** W11  
**Gold:** W11 GOLD  
**Br. Nickel:** W11 BNKL



Basin plug & chain, slotted

**Chrome:** W1  
**Gold:** W1 GOLD  
**Br. Nickel:** W1 BNKL



Tap hole stopper, chrome

**Code:** A49 CHR



Flat bottom bottle trap

**Code:** W13



Traditional bottle trap

**Chrome:** W14  
**Gold:** W14 GOLD  
**Br. Nickel:** W14 BNKL



Basin tap shut off valves (hot/cold)

**Code:** W28



Cistern tank on/off valve

**Chrome:** W25  
**Gold:** W25 GOLD  
**Br. Nickel:** W25 BNKL



Bidet trap  
**Code:** W27



Angled connector for  
telephone handset  
**Chrome:** V62

### Finish Options

A collection of our wastes are available in 3 distinct finishes.

These can be matched across the whole of the Burlington collection to create your perfect bathroom.



# SHOWERING

Our range of showers provide extensive options to create a perfect showering solution. Whether you prefer showering over a bath or within an enclosure, our range of thermostatic valves offer safe and controllable showering for the entire family. Partner with a wide range of enclosure styles with corresponding trays.

---

## KEY FEATURES

All our showers come as standard with the below key features.



### One Way Water

Our non-return valves ensure the flow of water in only one direction, ensuring heating efficiency, preventing siphonage of contaminated water and keeping your shower cartridge in excellent condition for longer.



### Airburst Shower Heads

By combining air and water, the pressure inside the shower head is increased. The power of a traditional shower head with up to 33% water saved.



### Thermostatic Showering

Within the valve there is an automatic adjuster which maintains temperature by adjusting the flow of each supply. This is useful in guarding against the possibility of scalding. If for instance, someone flushes a WC whilst you are showering, the flow of hot water will immediately be closed down to compensate for the reduced cold water flow.

---

## STYLE OPTIONS

Our showers are available with concealed or exposed valves.



### Concealed

A concealed shower valve creates a clean finish as the valve is hidden behind the wall.



### Exposed

An exposed shower valve is fitted onto the wall and has a more traditional feel.

# SHOWERING

134  
TRENT

135  
AVON

136  
EDEN

136  
SEVERN

137  
TAY

138  
STOUR

139  
ACCESSORIES

140  
RIVIERA

142  
ENCLOSURES

152  
TRAYS

---

## GUARANTEES

\*The lifetime guarantee is subject to online registration and represents the perceived lifetime of the product which is 25 years. For full details on guarantees please visit [burlingtonbathrooms.com/guarantee](http://burlingtonbathrooms.com/guarantee).

Showering

15  
YEAR

Guarantee\*

Enclosures

LIFETIME

Guarantee\*

# TRENT

## Concealed Thermostatic Showers

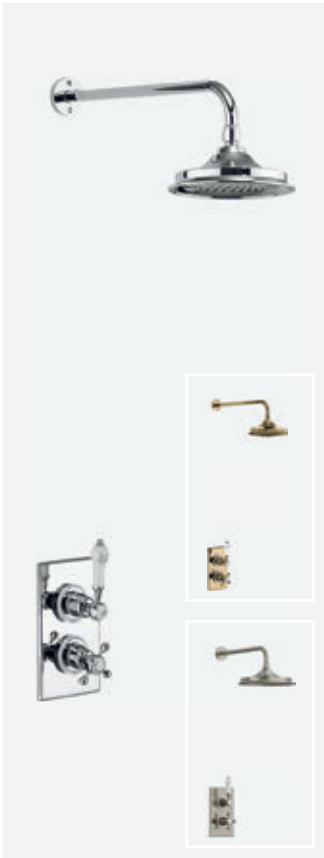

Thermostatic single function brass valve with independent temperature control

Traditional brass faceplate and Claremont handle with ceramic lever

390mm adjustable shower arm  
6", 9" or 12" AirBurst shower head  
(9" only for Gold and Brushed Nickel)

### White Ceramic

Chrome: TF1S+V16 **£614**  
Chrome: TF1S+V17 **£704**  
Chrome: TF1S+V60 **£758**  
Gold: TF1S GOLD+V17 **£894**  
Br. Nickel: TF1S BNKL+V17 **£894**



Thermostatic dual function brass valve with independent flow diverter and temperature control

Traditional brass faceplate and Claremont handle with ceramic lever

Wall outlet & 1500mm shower hose

Adjustable wall bracket and handset with ceramic handle

390mm adjustable shower arm

6", 9" or 12" AirBurst shower head  
(9" only for Gold and Brushed Nickel)

### White Ceramic

Chrome: TF2S+V16 **£930**  
Chrome: TF2S+V17 **£1,020**  
Chrome: TF2S+V60 **£1,074**  
Gold: TF2S GOLD+V17 **£1,450**  
Br. Nickel: TF2S BNKL+V17 **£1,450**



Thermostatic single function brass valve with independent temperature control

Traditional brass faceplate and Claremont handle with ceramic lever

Slide rail including the elbow, hose and handset with ceramic handle

### White Ceramic

TF1H **£595**

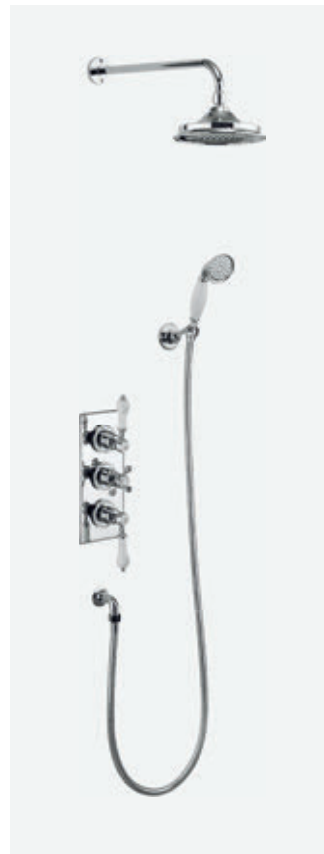

Thermostatic dual function brass valve with two independent on/off controls and central temperature control

Traditional brass faceplate and Claremont handle with ceramic lever

Wall outlet & 1500mm shower hose

Adjustable wall bracket and handset with ceramic handle

390mm adjustable shower arm

6", 9" or 12" AirBurst shower head

### White Ceramic

TF3S+V16 **£984**  
TF3S+V17 **£1,074**  
TF3S+V60 **£1,128**



# AVON

## Exposed Thermostatic Showers

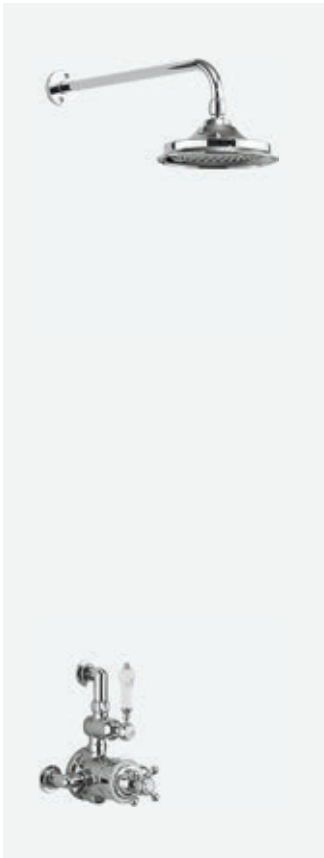

Thermostatic single function brass valve with independent temperature control

Traditional brass body and Claremont handle with ceramic lever

390mm adjustable shower arm  
6", 9" or 12" AirBurst shower head

### White Ceramic

AF1S+V16 **£794**  
AF1S+V17 **£884**  
AF1S+V60 **£938**



Thermostatic dual function brass valve with two independent on/off controls & central temperature control

Traditional brass body and Claremont handle & ceramic lever

Adjustable wall bracket, 1500mm shower hose and handset with ceramic handle

18 diameter vertical shower riser

355mm adjustable swivel shower arm

6", 9" or 12" AirBurst shower head  
(9" only for Gold and Brushed Nickel)

### White Ceramic

Chrome: BAF3S+V16 **£1,129**  
Chrome: BAF3S+V17 **£1,219**  
Chrome: BAF3S+V60 **£1,273**  
Gold: BAF3S GOLD+V17 **£1,475**  
Br. Nickel: BAF3S BNKL+V17 **£1,475**

## ADDITIONAL CHOICES

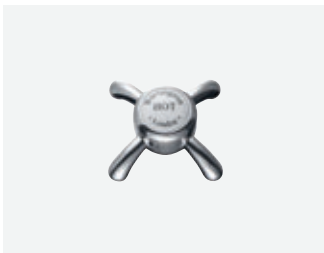

Shower valve handle options - Anglesey single valve handle

Chrome: V2 **£35**



Shower valve handle options - Birkenhead single valve handle

Chrome: V3 **£35**

### Shower Head Height

The standard riser pipe (V21) has a length of 856mm.

To increase the height of your shower head use the extended riser (V22) which has a length of 1814mm increasing the height by 958mm.

To order the extended riser simply add .EXT to the product code.  
For example BSF1S changes to BSF1S.EXT

# EDEN

## Exposed Thermostatic Showers

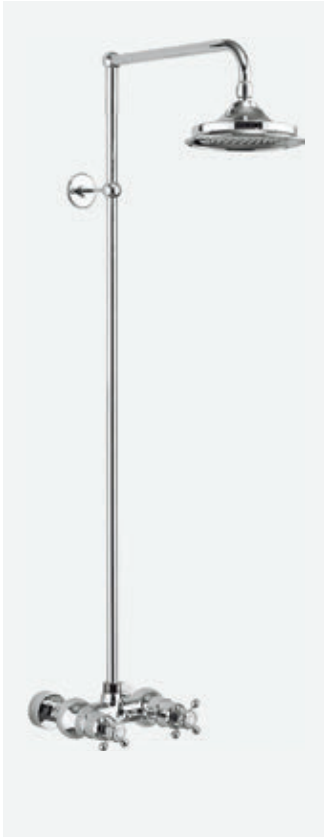

Thermostatic single outlet twin control valve with independent on / off flow and temperature control

Traditional brass body and Claremont handle with ceramic indices

18 diameter vertical brass shower riser

355mm adjustable swivel shower arm

6", 9" or 12" AirBurst shower head

### White Ceramic

BEF1S+V16	<b>£749</b>
BEF1S+V17	<b>£839</b>
BEF1S+V60	<b>£893</b>

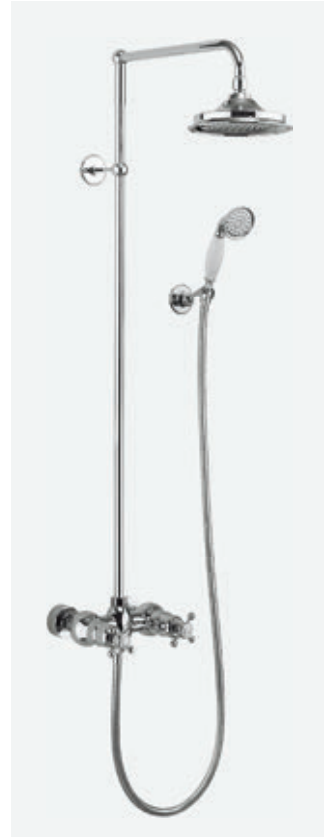

Thermostatic two outlet twin control valve with independent flow diverter and temperature control

Traditional brass body and Claremont handle with ceramic indices

Adjustable wall bracket, 1500mm shower hose and handset with ceramic handle

18 diameter vertical shower riser

390mm adjustable shower arm

6", 9" or 12" AirBurst shower head

### White Ceramic

BEF2S+V16	<b>£985</b>
BEF2S+V17	<b>£1,075</b>
BEF2S+V60	<b>£1,129</b>

# SEVERN

## Concealed Thermostatic Showers

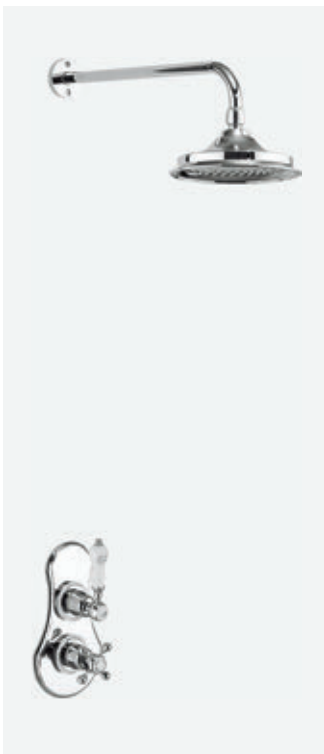

Thermostatic single function brass valve with independent temperature control

Traditional brass faceplate and Claremont handle with ceramic lever

390mm adjustable shower arm

6", 9" or 12" AirBurst shower head

### White Ceramic

VF1S+V16	<b>£614</b>
VF1S+V17	<b>£704</b>
VF1S+V60	<b>£758</b>

# TAY

## Bath Shower Thermostatic Showers



Thermostatic two outlet twin control bath shower mixer valve with independent flow diverter and temperature controls

Traditional brass body and Claremont handles, with ceramic indices

Brass bath spout with swivel function

Available deck or wall-mounted

S connector and bracket, 1500mm shower hose and handset with ceramic handle

### White Ceramic

Deck: T2DB **£1,059**  
Wall: T2WB **£935**



Thermostatic two outlet twin control bath shower mixer valve with independent flow diverter and temperature controls

Traditional brass body and Claremont handles, with ceramic indices

Brass bath spout with swivel function

Available deck or wall-mounted

18 diameter vertical shower riser

355mm adjustable swivel shower arm

6", 9" or 12" AirBurst shower head

### White Ceramic

Deck: BT2DS+V16 **£1,429**  
Deck: BT2DS+V17 **£1,519**  
Deck: BT2DS+V60 **£1,573**

## ADDITIONAL CHOICES



Shower valve handle options - Anglesey single valve handle

Chrome: V2 **£35**



Shower valve handle options - Birkenhead single valve handle

Chrome: V3 **£35**

### Shower Head Height

The standard riser pipe (V21) has a length of 856mm.

To increase the height of your shower head use the extended riser (V22) which has a length of 1814mm increasing the height by 958mm.

To order the extended riser simply add .EXT to the product code. For example BSF1S changes to BSF1S.EXT

# STOUR

## Exposed Thermostatic Showers

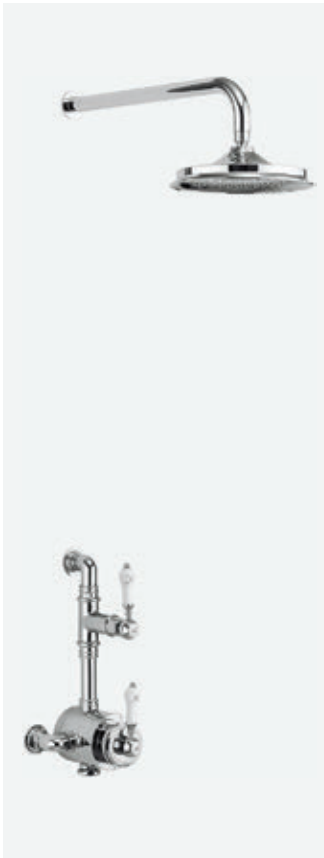

Thermostatic single function brass valve with independent temperature control

Traditional brass body and Claremont handle with ceramic lever

6", 9" or 12" AirBurst shower head

### White Ceramic

BF1S+V16	£1,260
BF1S+V17	£1,350
BF1S+V60	£1,404



Thermostatic single function brass valve with independent temperature control

Traditional brass body and Claremont handle with ceramic lever

28 diameter vertical shower riser

450mm adjustable fixed shower arm

Soap basket

6", 9" or 12" AirBurst shower head

### White Ceramic

BF2S+V16	£1,480
BF2S+V17	£1,570
BF2S+V60	£1,624



Thermostatic dual function brass valve with two independent on / off controls and central temperature control

Traditional brass body, Claremont handle with ceramic lever

Fixed cradle, 1500mm shower hose and handset with ceramic handle

28 diameter vertical shower riser

450mm adjustable fixed shower arm

Soap basket

6", 9" or 12" AirBurst shower head

### White Ceramic

BF3S+V16	£1,780
BF3S+V17	£1,870
BF3S+V60	£1,924

# ACCESSORIES



Soap Basket

**Chrome: V23      £59**



Cradle

**Chrome: V24      £59**



Slide Rail

**Chrome: V33      £119**



Spout Fitting

**Chrome: V32      £95**



Extended Vertical Riser Rail

**Chrome: V22      £169**  
**Gold: V22 GOLD      £309**  
**Br. Nickel: V22 BNKL      £309**



Ceramic Handset, Hose & Diverter

**Chrome: V27      £235**

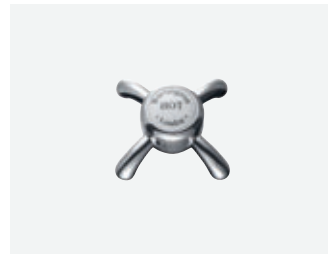

Shower valve handle options - Anglesey single valve handle

**Chrome: V2      £35**



Shower valve handle options - Birkenhead single valve handle

**Chrome: V3      £35**



# RIVIERA

Create your perfect showering combination by selecting from the below, available in both Chrome and Gold



Single outlet version, for showers with either a fixed overhead or a flexible hose and handspray

Two outlet version for two shower outlets or for one shower and bath filling. The two outlet valve can be installed with both a fixed and flexible shower, it has a built-in diverter to switch between the two

### Single Outlet

Chrome: R1SV CHR **£570**  
Gold: R1SV GOLD **£620**

### Dual Outlet

Chrome: R2SV CHR **£570**  
Gold: R2SV GOLD **£620**

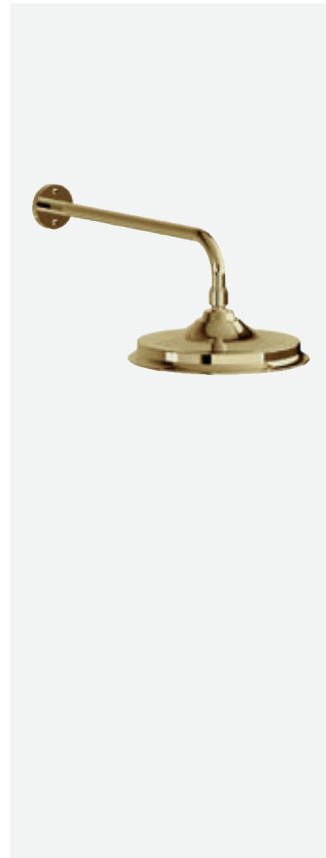

Straight shower arm

6", 9" or 12" AirBurst shower head  
(9" only for Gold)

### Shower Arm

Chrome: V11 **£65**  
Gold: V11 GOLD **£105**

### Shower Head

6" Chrome: V16 **£145**  
9" Chrome: V17 **£235**  
12" Chrome: V60 **£289**  
9" Gold: V17 GOLD **£225**



100mm slidebar with adjustable bracket

### Slidebar

Chrome: RIV37 CHR **£145**  
Gold: RIV37 GOLD **£289**

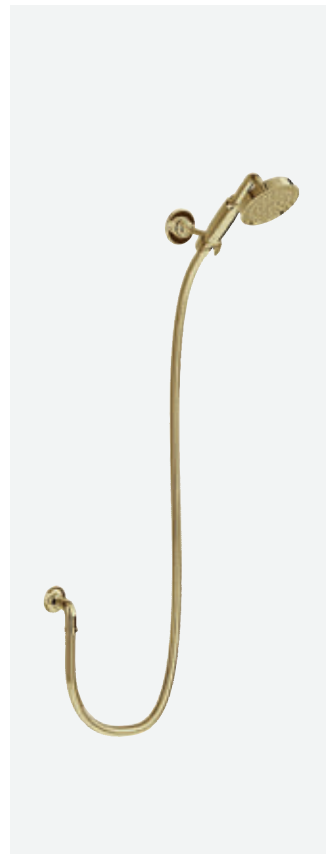

The flexible hose and handspray is supplied with wall outlet and shower station as shown. It can also be used with optional slide bar.

### Fixed Hose and Handspray

Chrome: RIV20 CHR **£289**  
Gold: RIV20 GOLD **£319**

For the full Riviera range visit  
[burlingtonbathrooms.com/riviera](http://burlingtonbathrooms.com/riviera)



For full details on our Riviera Showering range go to [burlingtonbathrooms.com/guides/riviera-showering](http://burlingtonbathrooms.com/guides/riviera-showering)

# WALK IN CONFIGURATIONS

Once you have identified your space you can create your personalised showering solution; with our flexible modular glass panels, profiles and stabilising fixings the layout options are almost endless.

When choosing your configuration, we recommend you allow 500mm minimum entry space.

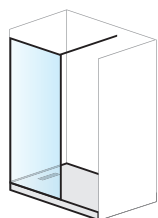

## Recess

- 1 x Glass Panel
- 1 x Wall Profile
- 1 x Bracing Bar (Wall or Ceiling)

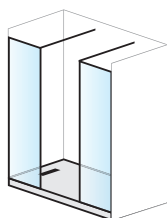

## Recess with Double Panel

- 2 x Glass Panels
- 2 x Wall Profiles
- 2 x Bracing Bars (Wall or Ceiling)

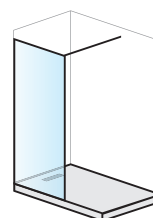

## Open Ended

- 1 x Glass Panel
- 1 x Wall Profile
- 1 x Bracing Bar (Wall or Ceiling)

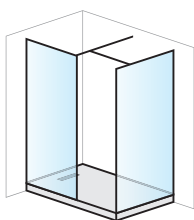

## Corner with T Bracing Bar

- 2 x Glass Panels (up to 1000mm max.)
- 2 x Wall Profiles
- 1 x T Bracing Bar

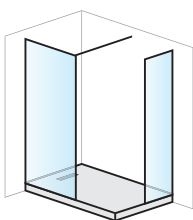

## Corner

- 1 x Glass Panel
- 1 x Glass Panel (up to 500mm max.)
- 2 x Wall Profiles
- 1 x Bracing Bar (Wall or Ceiling)

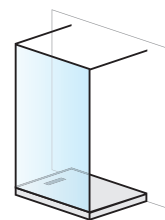

## Walk Through

- 1 x Glass Panel
- 2 x Glass to Wall Bracing Bars

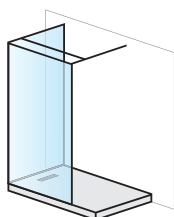

## Glass Corner with T Bracing Bar

- 2 x Glass Panels (up to 1000mm max.)
- 1 x Wall Profile
- 1 x T Bracing Bar
- 1 x Glass to Glass Corner Seal

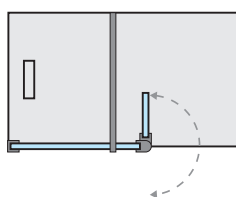

## 180° Hinged Deflector Panel

Available in 300mm, our hinged panel rotates through 180° for easier access. The colour matching hinges and clear seal give your walk in a seamless appearance.

- 1 x Glass Panel for Hinged Deflector
- 1 x Deflector Panel 180° Hinges (pair)

We wouldn't recommend installing a deflector panel if you have chosen a glass to ceiling bracing bar.

## Additional Design Flexibility

The configurations shown are the most typical options; if you require something different please talk to your local bathroom specialist.

For further installation information or to find your local retailer visit [burlingtonbathrooms.com](http://burlingtonbathrooms.com)



· NEW ·



# WALK INS



1400 x 900 Corner Walk In with Hinged Deflector Panel - Shown with Trent Shower

- 2000mm High
- Adjustable up to 15mm from each wall
- Safety glass is 8mm thick
- Easy clean coating
- Reversible panels
- 8mm toughened safety glass to BS EN 14428
- Choice of bracing bar options
- Suitable for tray or tiled floors (wetroom)

High Flow Vortex Shower Waste

**Chrome:** Z1205      **£19**  
**Gold:** Z1205GOLD      **£65**  
**Br. Nickel:** Z1205BNKL      **£65**

## 8mm Toughened Glass Panels

Width	Code	Price
255	BU030008CF	<b>£135</b>
355	BU040008CF	<b>£155</b>
455	BU050008CF	<b>£185</b>
555	BU060008CF	<b>£210</b>
655	BU070008CF	<b>£240</b>
755	BU080008CF	<b>£265</b>
855	BU090008CF	<b>£295</b>
955	BU100008CF	<b>£315</b>
1055	BU110008CF	<b>£350</b>
1155	BU120008CF	<b>£370</b>
1355	BU140008CF	<b>£395</b>

Panels up to 500mm can be supported with a wall profile alone, panels 600mm and wider require a bracing bar. It is important to take the measurements after the tray is installed and the walls are tiled.

## Optional Glass Bottom Seal

Size	Code	Price
1400 x 800	BUSEAL1400X8	<b>£10</b>

Must be cut to length on installation.

## Recommended Trays

Range	Page
35mm Shower Trays	152

---

## CHROME

### Stabilising Fixings

Part	Size	Code	Price
Glass to Wall Bracing Bar	1200	BUBRACEC	£125
T Bracing Bar	1200 x 1200	BUTBRACEC	£220
Glass to Ceiling Bracing Bar	600 High	BUCEILBRACEC	£115
Glass to Glass Corner Seal	2000 x 10	BUSEAL2000X8	£20

### Hinged Deflector Panel Fittings

Part	Size	Code	Price
Deflector Panel 180° Hinges	-	BUDEFHINGEC	£215
Hinged Deflector Glass with Seal	300	BUDEFLEC300	£160

### Wall Profile

Part	Size	Adjustment	Code	Price
Wall Profile with Seal	2000	15	BUPROFILEC	£225

---

## GOLD

### Stabilising Fixings

Part	Size	Code	Price
Glass to Wall Bracing Bar	1200	BUBRACEGO	£205
T Bracing Bar	1200 x 1200	BUTBRACEGO	£350
Glass to Ceiling Bracing Bar	600 High	BUCEILBRACEGO	£175
Glass to Glass Corner Seal	2000 x 10	BUSEAL2000X8	£20

### Hinged Deflector Panel Fittings

Part	Size	Code	Price
Deflector Panel 180° Hinges	-	BUDEFHINGEGO	£285
Hinged Deflector Glass with Seal	300	BUDEFLEC300	£160

### Wall Profile

Part	Size	Adjustment	Code	Price
Wall Profile with Seal	2000	15	BUPROFILEGO	£335

---

## BRUSHED NICKEL

### Stabilising Fixings

Part	Size	Code	Price
Glass to Wall Bracing Bar	1200	BUBRACEL	£205
T Bracing Bar	1200 x 1200	BUTBRACEL	£350
Glass to Ceiling Bracing Bar	600 High	BUCEILBRACEL	£175
Glass to Glass Corner Seal	2000 x 10	BUSEAL2000X8	£20

### Hinged Deflector Panel Fittings

Part	Size	Code	Price
Deflector Panel 180° Hinges	-	BUDEFHINGEL	£285
Hinged Deflector Glass with Seal	300	BUDEFLEC300	£160

### Wall Profile

Part	Size	Adjustment	Code	Price
Wall Profile with Seal	2000	15	BUPROFILEL	£335

# HINGED DOORS

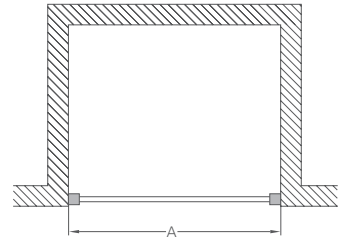

- 1950mm High
- Adjustable up to 20mm from each wall
- Constructed from aluminium
- Can be installed with or without chrome ball header
- Safety glass is 8mm thick
- 3M™ easy clean coating

High Flow Vortex Shower Waste

**Chrome: Z1205      £19**

900 x 900 Hinged Doors - Shown with Trent Shower

## Enclosures

Width	Adjustment min-max	Code	Price
800	760 - 800	C20	<b>£705</b>
900	860 - 900	C21	<b>£779</b>

## Recommended Trays

Range	Page
35mm Shower Trays	152

# HINGED DOORS & SIDE PANELS

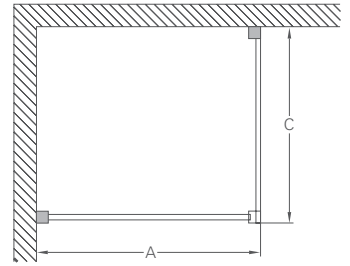

- 1950mm High
- Adjustable up to 20mm from each wall
- Constructed from aluminium
- Can be installed with or without chrome ball header
- Safety glass is 8mm thick
- 3M™ easy clean coating

High Flow Vortex Shower Waste

**Chrome:** Z1205      **£19**

900 x 900 Hinged Doors & Side Panel - Shown with Severn Shower

## Enclosures

Size	Adjustment min-max	Codes	Price
800 x 800	770 - 790	C20 + C13	<b>£1,174</b>
800 x 900	770 - 790 / 870 - 890	C20 + C14	<b>£1,194</b>
900 x 800	770 - 790 / 870 - 890	C21 + C13	<b>£1,248</b>
900 x 900	870 - 900	C21 + C14	<b>£1,268</b>

## Recommended Trays

Range	Page
35mm Shower Trays	152

# SLIDING DOORS

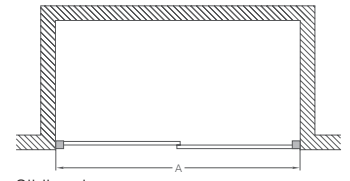

Sliding door

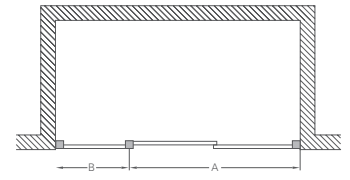

Sliding door with in line panel

- 1950mm High
- Adjustable up to 20mm from each wall
- Constructed from aluminium
- Can be installed with or without chrome ball header
- Safety glass is 8mm thick
- 3M™ easy clean coating

High Flow Vortex Shower Waste

**Chrome: Z1205      £19**

1200 x 900 Sliding Doors with Inline Panels - Shown with Trent Shower

## Enclosures

Width	Adjustment min-max	Code	Price
1200	1160 - 1200	C7S	<b>£959</b>

## Recommended Trays

Range	Page
35mm Shower Trays	152



# SLIDING DOORS WITH SIDE PANELS

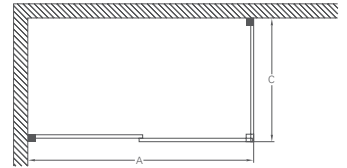

Sliding door with side panel

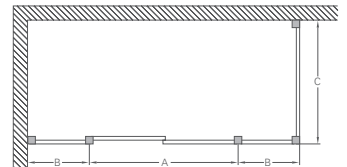

Sliding door with in line and side panel

- 1950mm High
- Adjustable up to 20mm from each wall
- Constructed from aluminium
- Can be installed with or without chrome ball header
- Safety glass is 8mm thick
- 3M™ easy clean coating

High Flow Vortex Shower  
Waste

**Chrome: Z1205      £19**

1200 x 900 Sliding Doors with Inline & Side Panels - Shown with Avon Shower

## Enclosures

Size	Adjustment min-max	Codes	Price
1200 x 800	770 - 790 / 1070 - 1090	C7S + C13	<b>£1,428</b>
1200 x 900	870 - 890 / 1070 - 1090	C7S + C14	<b>£1,448</b>

## Recommended Trays

Range	Page
35mm Shower Trays	152



# QUADRANTS

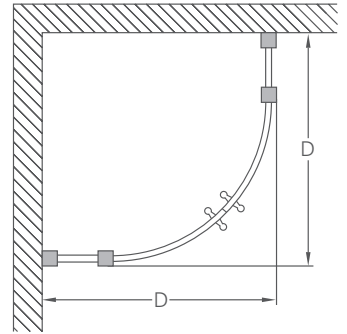

- 1950mm High
- Adjustable up to 20mm from each wall
- Constructed from aluminium
- Can be installed with or without chrome ball header
- Safety glass is 8mm thick
- 3M™ easy clean coating

High Flow Vortex Shower  
Waste

**Chrome:** Z1205      **£19**

900 x 900 Quadrant - Shown with Stour Shower

## Enclosures

Size	Adjustment min-max	Code	Price
800 x 800	770 - 790	C22	<b>£1,174</b>
900 x 900	870 - 890	C23	<b>£1,194</b>

## Recommended Trays

Range	Page
35mm Shower Trays	152

# 35MM SHOWER TRAYS



Square shower trays

Length	Width	Code	Price	Panel Pack
760	760	Z1159	<b>£139</b>	H
800	800	Z1160	<b>£145</b>	H
900	900	Z1161	<b>£165</b>	H



Quadrant shower trays

Length	Width	Code	Price	Panel Pack
800	800	Z1192	<b>£145</b>	D
900	900	Z1193	<b>£165</b>	D



Rectangle - corner waste

Length	Width	Code	Price	Panel Pack
900	760	Z1163	<b>£165</b>	H
900	800	Z1164	<b>£169</b>	H
1000	700	Z1165	<b>£175</b>	A
1000	760	Z1166	<b>£179</b>	A
1000	800	Z1167	<b>£185</b>	A
1000	900	Z1168	<b>£199</b>	A
1100	800	Z1171	<b>£235</b>	B
1100	900	Z1172	<b>£239</b>	B
1200	700	Z1173	<b>£245</b>	B
1200	760	Z1174	<b>£249</b>	B



Large rectangle

Length	Width	Code	Price	Anti-Slip Code	Price	Panel Pack
1500	800	Z1181	<b>£315</b>	Z1181A	<b>£385</b>	B
1500	900	Z1361	<b>£325</b>	Z1361A	<b>£389</b>	B
1600	700	Z1182	<b>£329</b>	Z1182A	<b>£395</b>	B
1600	800	Z1231	<b>£315</b>	Z1231A	<b>£399</b>	B
1700	700	Z1183	<b>£349</b>	Z1183A	<b>£409</b>	B
1700	760	Z1184	<b>£365</b>	Z1184A	<b>£419</b>	B
1700	800	Z1185	<b>£369</b>	Z1185A	<b>£449</b>	B
1700	900	-	-	Z1341A	<b>£475</b>	B

\* No panel pack available



Rectangle - off-centre waste

Length	Width	Code	Price	Anti-Slip Code	Price	Panel Pack
1200	800	Z1175	<b>£255</b>	Z1175A	<b>£345</b>	B
1200	900	Z1176	<b>£259</b>	Z1176A	<b>£349</b>	B
1200	1000	Z1230	<b>£339</b>	-	-	B
1400	800	Z1177	<b>£295</b>	Z1177A	<b>£365</b>	B
1400	900	Z1178	<b>£299</b>	Z1178A	<b>£369</b>	B



Shower tray panel packs

Code	Price	Panel Pack
Z1209 (ZP1.ZL1)	£128	A
Z1210 (ZP2.ZL2)	£158	B
Z1212 (ZP4.ZL4)	£108	D
Z1213 (ZP5.ZL3)	£138	E
Z1215 (ZP4.ZL5)	£118	G
Z1216 (ZP1.ZL4)	£128	H
Z1217 (ZP1.ZL2)	£148	I
Z1218 (ZP5.ZL4)	£138	J



High Flow Vortex Shower Waste

Finish	Width	Depth	Height	Code	Price
Chrome	115	130	110	Z1205	£19
Gold	115	130	110	Z1205GOLD	£65
Br. Nickel	115	130	110	Z1205BNKL	£65

# ACCESSORIES

Burlington bathrooms offer a range of accessories, radiators, mirrors and lights for the perfect finishing touch to your traditionally styled bathroom.

---

## COLOUR OPTIONS

Continue luxury styling throughout your classic themed bathroom with a range of accessories combining Chrome, Gold or Brushed Nickel plated solid brass with White ceramic so your bathroom not only looks beautifully traditional but is effortlessly functional too.



**Accessories**

Continue luxury styling throughout your classic themed bathroom with a range of accessories in a selection of finishes. Choose from Chrome, Gold or Brushed Nickel finish.



**Radiators**

Complete your traditional bathroom with a choice of radiators in either White and Chrome, Black and Chrome, Chrome, Gold or Brushed Nickel.



**Mirrors**

Add a finishing touch to your bathroom with a Burlington mirror. Opt for curved, rectangular or arched mirrors.



**Lights**

Choose from a selection of Burlington and Arcade lights with Chrome or Polished Nickel bases and a choice of either glass or chiffon shades.

# ACCESSORIES

156  
ACCESSORIES

158  
RADIATORS

159  
MIRRORS

160  
LIGHTS

---

## GUARANTEES

\*For full details on guarantees please visit  
[burlingtonbathrooms.com/guarantee](http://burlingtonbathrooms.com/guarantee).

Accessories

15  
YEAR

Guarantee\*

Mirrors

5  
YEAR

Guarantee\*

Radiators

5  
YEAR

Guarantee\*

Lights

5  
YEAR

Guarantee\*

# ACCESSORIES



Soap Dish

**W:** 160 **L:** 150 **H:** 60

**Chrome:** A1 CHR  
**Gold:** A1 GOLD  
**Br. Nickel:** A1 BNKL



Tumbler Holder

**W:** 80 **L:** 120 **H:** 110

**Chrome:** A2 CHR  
**Gold:** A2 GOLD  
**Br. Nickel:** A2 BNKL



WC Brush Holder

**W:** 100 **L:** 150 **H:** 430

**Chrome:** A8 CHR  
**Gold:** A8 GOLD  
**Br. Nickel:** A8 BNKL



Towel Ring

**W:** 170 **L:** 60 **H:** 200

**Chrome:** A3 CHR  
**Gold:** A3 GOLD  
**Br. Nickel:** A3 BNKL

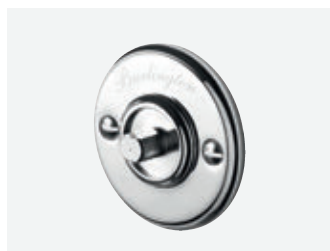

Accessory Back Plate

**W:** 30 **L:** 60 **H:** 60

**Chrome:** G13



Single Soap Dispenser

**W:** 80 **L:** 140 **H:** 210

**Chrome:** A19 CHR  
**Gold:** A19 GOLD  
**Br. Nickel:** A19 BNKL



Double Soap Dispenser

**W:** 190 **L:** 130 **H:** 210

**Code:** A20 CHR



WC Roll Holder

**W:** 80 **L:** 180 **H:** 120

**Chrome:** A5 CHR  
**Gold:** A5 GOLD  
**Br. Nickel:** A5 BNKL



WC Roll Holder

**W:** 100 **L:** 180 **H:** 100

**Code:** A16 CHR



Spire WC Roll Holder

**W:** 170 **L:** 60 **H:** 250

**Code:** A45 CHR

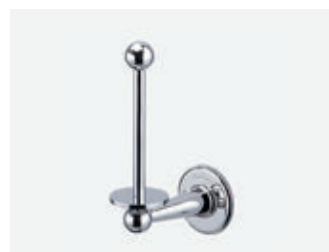

Spare WC Roll Holder

**W:** 120 **L:** 60 **H:** 80

**Code:** A6 CHR



Robe Hook

**W:** 60 **L:** 60 **H:** 60

**Chrome:** A14 CHR  
**Gold:** A14 GOLD  
**Br. Nickel:** A14 BNKL

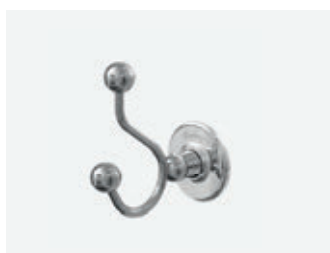

Double Robe Hook

**W:** 60 **L:** 110 **H:** 120

**Chrome:** A4 CHR  
**Gold:** A4 GOLD  
**Br. Nickel:** A4 BNKL

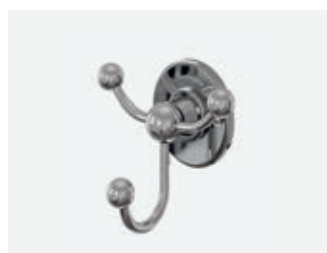

Triple Robe Hook

**W:** 100 **L:** 70 **H:** 90

**Code:** A47 CHR



Medium Ornate Bracket

**W:** 230 **L:** 20 **H:** 160

**Code:** T32 CHR

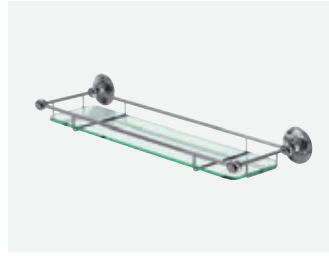

Glass Shelf with Railing

**W:** 530 **L:** 160 **H:** 60

**Chrome:** A18 CHR  
**Gold:** A18 GOLD



Brass Extendible Bath Rack

**W:** 590-900 **L:** 210 **H:** 90

**Code:** A27 CHR



Soap Basket

**W:** 140 **L:** 120 **H:** 60

**Code:** A13 CHR

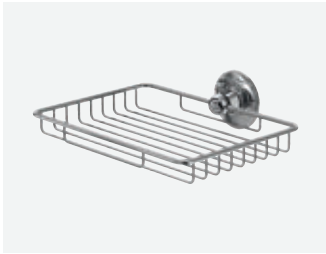

Sponge Basket

**W:** 220 **L:** 180 **H:** 60

**Code:** A15 CHR



Wire Basket

**W:** 330 **L:** 160 **H:** 90

**Code:** A23 CHR



Corner Basket

**W:** 220 **L:** 220 **H:** 60

**Code:** A21 CHR



Deep Corner Basket

**W:** 280 **L:** 280 **H:** 90

**Code:** A22 CHR



Towel Rack

**W:** 660 **L:** 320 **H:** 140

**Chrome:** A46 CHR  
**Gold:** A46 GOLD



Single Towel Rail

**W:** 550 **L:** 60 **H:** 60

**Code:** A7 CHR



Double Towel Rail

**W:** 660 **L:** 150 **H:** 170

**Code:** A17 CHR

## COLOUR CHOICES

A selection of our accessories are available in a range of finishes and accents. See below for a few examples. For details on exact finishes visit our website.



Chrome

Brushed Nickel

Gold

# RADIATORS



Trafalgar  
**W:** 642 **L:** 235 **H:** 950  
**Chrome:** R1 CHR  
**Gold:** R1 GOLD  
**Br. Nickel:** R1 BNKL



Trafalgar Black  
**W:** 642 **L:** 235 **H:** 950  
**Code:** R1 CHR BLA



Bloomsbury  
**W:** 497 **L:** 235 **H:** 950  
**Chrome:** R2 CHR  
**Gold:** R2 GOLD  
**Br. Nickel:** R2 BNKL



Bloomsbury Black  
**W:** 497 **L:** 235 **H:** 950  
**Code:** R2 CHR BLA



Chaplin  
**W:** 542 **L:** 126 **H:** 1142  
**Code:** R12 CHR



Vincent  
**W:** 642 **L:** 235 **H:** 950  
**Code:** R5 CHR



Berkeley  
**W:** 642 **L:** 235 **H:** 950  
**Chrome:** R4 CHR  
**Gold:** R4 GOLD  
**Br. Nickel:** R4 BNKL



Clever  
**W:** 642 **L:** 235 **H:** 720  
**Chrome:** R3 CHR  
**Gold:** R3 GOLD  
**Br. Nickel:** R3 BNKL



Strand  
**W:** 642 **L:** 390 **H:** 404  
**Code:** R11 CHR



Straight Radiator Valves  
**Chrome:** R7 CHR  
**Gold:** R7 GOLD  
**Br. Nickel:** R7 BNKL



Angled Radiator Valves  
**Chrome:** R6 CHR  
**Gold:** R6 GOLD  
**Br. Nickel:** R6 BNKL

## Suitable for Chrome only



300W summer electric heating kit for Trafalgar and Bloomsbury

**Code:** BUR10

200W summer electric heating kit for Chaplin and Vincent

**Code:** BUR9

100W summer electric heating kit for Berkeley and Cleaver

**Code:** BUR8

Type	$\Delta T=50^{\circ}C$ Watts	$\Delta T=55^{\circ}C$ Watts	$\Delta T=60^{\circ}C$ Watts	BTU's	DM3
Trafalgar	475	540	600	2047	7.2
Bloomsbury	356	400	445	1518	5.0
Vincent	219	250	280	955	2.9
Berkeley	180	210	240	819	2.4
Cleaver	164	190	210	717	2.2
Strand	218	250	280	955	2.4
Chaplin	235	268	300	1024	3.4

Maximum capacity when using a heating element is 90% of full capacity. Please consult the installation guide for each model.

Burlington radiators offer a broad range of various styles.

There are options here to complement your traditional bathroom beautifully. All Burlington radiators except the Strand (R11 CHR) are designed to work with the extra fitting of an electric summer heating kit, allowing warm towels all year round.



# MIRRORS



Arched

**W: 500 D: 30 H: 700**

**Code: A9**



Rectangular

**W: 500 D: 30 H: 700**

**Code: A11**



Curved

**W: 700 D: 30 H: 700**

**Code: A38**



Cosmetic Wall Mirror

**W: 180 D: 285 H: 340-440**

**Code: A57 CHR**



Rectangular Swivel Mirror with Curved Corners

**W: 590 D: 66 H: 620**

**Chrome: A40 CHR**  
**Gold: A40 GOLD**  
**Br. Nickel: A40 BNKL**



# LIGHTS

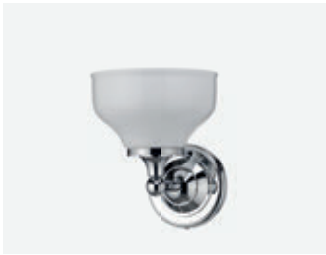

Round Light with Chrome Base and Cup Frosted Glass Shade

**Code:** EL/BL11



Round Light with Chrome Base and Vase Clear Glass Shade

**Code:** EL/BL14



Round Light with Chrome Base and Tube Frosted Glass Shade

**Code:** EL/BL13



Round Light with Chrome Base and White Fine Pleated Shade

**Code:** EL/BL12

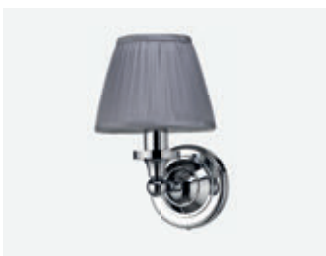

Round Light with Chrome Base and Silver Chiffon Shade

**Code:** EL/BL15

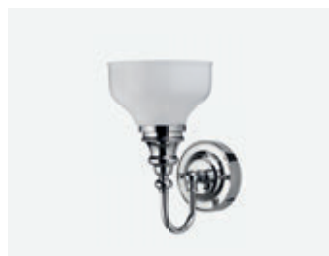

Ornate Light with Chrome Base and Cup Frosted Glass Shade

**Code:** EL/BL21

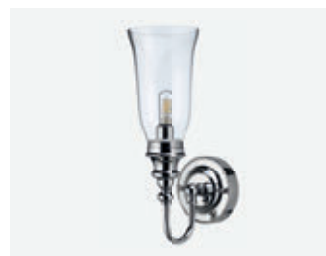

Ornate Light with Chrome Base and Vase Clear Glass Shade

**Code:** EL/BL24



Ornate Light with Chrome Base and Tube Frosted Glass Shade

**Code:** EL/BL23



Ornate Light with Chrome Base and White Fine Pleated Shade

**Code:** EL/BL22



Ornate Light with Chrome Base and Silver Chiffon Shade

**Code:** EL/BL25

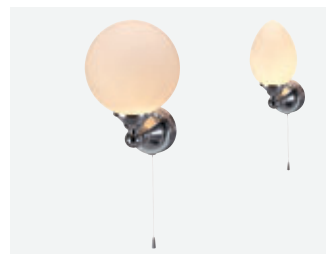

Edwardian Chrome Single Round LED Light

**Round:** T50  
**Elliptical:** T52



Arcade Oval Light with Polished Nickel Base and Cup Frosted Glass Shade

**Code:** EL/AL11



Arcade Oval Light with Polished Nickel Base and Vase Clear Glass Shade

**Code:** EL/AL14



Arcade Oval Light with Polished Nickel Base and Tube Frosted Glass Shade

**Code:** EL/AL13



Arcade Oval Light with Polished Nickel Base and White Fine Pleated Shade

**Code:** EL/AL12



Arcade Oval Light with Polished Nickel Base and Silver Chiffon Shade

**Code:** EL/AL15

## ONLINE

You can view all of the Burlington collections on our website alongside exclusive videos, styling tips for your bathroom and technical details about the product. If you would prefer to view in person, you can use the website's showroom locator to find your nearest Burlington display.

---

## IN STORE

There is a local Burlington specialist near you.  
To find your nearest retailer, search our website under  
[burlingtonbathrooms.com/find-a-retailer](http://burlingtonbathrooms.com/find-a-retailer)

---

## GUARANTEES

All Burlington products are made using the highest quality materials and are produced to meet or exceed European and U.K. Standards. With correct installation and use the products will give many years of trouble-free service.

All products within the brand are covered by Burlington's guarantees. Burlington guarantees are subject to online registration. Lifetime guarantees represent the perceived lifetime of the product which is 25 years.

For more information on guarantees visit  
[burlingtonbathrooms.com/guarantee](http://burlingtonbathrooms.com/guarantee)

---

## INSPIRATION

Follow us on



[burlingtonbathrooms.com](http://burlingtonbathrooms.com)

Due to continuous product improvements we reserve the right to change the product specification without prior notice. The text, images and layout of this catalogue are protected by copyright and other intellectual property rights. All images within this brochure are, where possible, a true representation of our products. Some colours may vary. Please visit the websites for more information.

Our websites should be used as reference for the most up to date product specification.



Part of the  
**Bathroom Brands Group**  
burlingtonbathrooms.com

Lake View House  
Rennie Drive, Dartford  
Kent, DA1 5FU

July 2023

All measurements are represented in mm.